



**Geotextile Sand Filter**

Puerto Rico  
Design & Installation Manual



**eljen**  
CORPORATION

*Innovative Onsite Products & Solutions Since 1970*

January 2020  
[www.eljen.com](http://www.eljen.com)

# Table of Contents

---

SUBJECT	PAGE
GLOSSARY OF TERMS .....	3
GSF SYSTEM DESCRIPTION .....	4
1.0 CONDITIONS FOR USE .....	5
1.1 SYSTEM DESIGN .....	5
2.0 TRENCH DESIGN AND INSTALLATION .....	6
2.1 TRENCH DESIGN EXAMPLE .....	7
2.2 TRENCH DESIGN INSTALLATION STEPS .....	8
3.0 BED DESIGN AND INSTALLATION .....	9
3.1 BED DESIGN EXAMPLE .....	100
3.2 BED DESIGN INSTALLATION STEPS .....	111
4.0 LEVEL ABOVE GRADE DESIGN AND INSTALLATION .....	122
4.1 LEVEL ABOVE GRADE DESIGN EXAMPLE .....	144
4.2 LEVEL ABOVE GRADE INSTALLATION STEPS .....	15
5.0 SLOPED ABOVE GRADE BED DESIGN AND INSTALLATION .....	16
5.1 SLOPED ABOVE GRADE BED DESIGN EXAMPLE .....	18
5.2 SLOPED ABOVE GRADE DESIGN INSTALLATION STEPS .....	19
6.0 DOSING DISTRIBUTION REQUIREMENTS .....	200
7.0 PRESSURE DISTRIBUTION REQUIREMENTS .....	200
8.0 PUMP CONTROLS .....	22
9.0 SYSTEM VENTILATION .....	22
GSF DRAWINGS AND TABLES	
DRAWINGS	
FIGURE 1: GSF SYSTEM OPERATION .....	44
FIGURE 2: A42 TRENCH CROSS SECTION .....	66
FIGURE 3: PLAN VIEW –TRENCH SYSTEM.....	77
FIGURE 4: SECTION VIEW – TRENCH SYSTEM – LEVEL SITE .....	77
FIGURE 5: SECTION VIEW – TRENCH SYSTEM – SLOPING SITE.....	77
FIGURE 6: BED CROSS SECTION.....	99
FIGURE 7: PLAN VIEW – BED SYSTEM .....	1010
FIGURE 8: SECTION VIEW – 2 LATERAL BED SYSTEM .....	1010
FIGURE 9: SECTION VIEW – 3 LATERAL BED SYSTEM .....	1010
FIGURE 10: LEVEL ABOVE GRADE CROSS SECTION .....	1212
FIGURE 11: PLAN VIEW – BED SYSTEM – LEVEL SITE.....	1414
FIGURE 12: CROSS SECTION VIEW – BED SYSTEM – LEVEL SITE .....	1414
FIGURE 13: SLOPED ABOVE GRADE BED CROSS SECTION .....	1616
FIGURE 14: PLAN VIEW – BED SYSTEM –SLOPING SITE .....	1818
FIGURE 15: CROSS SECTION VIEW –BED SYSTEM – SLOPING SITE .....	1818
FIGURE 16: PRESSURE CLEAN OUT .....	2020
FIGURE 17: CONTOURED TRENCH PRESSURE DISTRIBUTION .....	2121
FIGURE 18: GSF WITH 4" VENT EXTENDED TO CONVENIENT LOCATION.....	2222
TABLES	
TABLE 1: SPECIFIED SAND SIEVE REQUIREMENTS .....	3

## Glossary of Terms

---

<b>A42 Module</b>	48" x 24" x 7" (L x W x H)
<b>Cover Fabric</b>	The geotextile cover fabric (provided by manufacturer) that is placed over the GSF modules. Barrier material cannot be substituted.
<b>Design Flow</b>	The estimated peak flow that is used to size a GSF system is 150 gallons per day per bedroom.
<b>GSF Unit</b>	The Eljen Geotextile Sand Filter Modules and the 6-inch sand layer at the base and 6 inches along the sides of the modules.
<b>GSF Module</b>	The individual module of a GSF system. The module is comprised of a cusped plastic core and geotextile fabric.
<b>Specified Sand</b>	To ensure proper system operation, the system <b>MUST</b> be installed using ASTM C33 Sand.  ASTM C33 sand will have less than 10% passing the #100 Sieve and less than 5% passing the # 200 sieve. Ask your material supplier for a sieve analysis to verify that your material meets the required specifications.

**TABLE 1: SPECIFIED SAND SIEVE REQUIREMENTS**

ASTM C33 SAND SPECIFICATION		
Sieve Size	Sieve Square Opening Size	Specification Percent Passing (Wet Sieve)
3/8 inch	9.52 mm	100
No. 4	4.76 mm	95 - 100
No. 8	2.38 mm	80 - 100
No. 16	1.19 mm	50 - 85
No. 30	590 µm	25 - 60
No. 50	297 µm	5 - 30
No. 100	149 µm	0 - 10
No. 200	75 µm	0 - 5

# GSF System Description

## Primary Treatment Zone

- Perforated pipe is centered above the GSF module to distribute septic effluent over and into corrugations created by the cusped core of the geotextile module.
- Septic effluent is filtered through the Bio-Matt (geotextile) fabric. The module's unique design provides increased surface area for biological treatment that greatly exceeds the module's footprint.
- Open air channels, within the module, support aerobic bacterial growth on the modules geotextile fabric interface, surpassing the surface area required for traditional absorption systems.
- A cover fabric covers the top and sides of the GSF module and protects the Specified Sand and soil from clogging, while maintaining effluent storage within the module.

## Secondary Treatment Zone

- Effluent drips into the Specified Sand layer and supports unsaturated flow into the native soil. This Specified Sand/soil interface maintains soil structure, thereby maximizing the available absorption interface in the native soil. The Specified Sand supports nitrification of the effluent, which reduces oxygen demand in the soil, thus minimizing soil clogging from anaerobic bacteria.
- The Specified Sand layer also protects the soil from compaction and helps maintain cracks and crevices in the soil. This preserves the soil's natural infiltration capacity, which is especially important in finer textured soils, where these large channels are critical for long-term performance.
- Native soil provides final filtration and allows for groundwater recharge.

FIGURE 1: GSF SYSTEM OPERATION

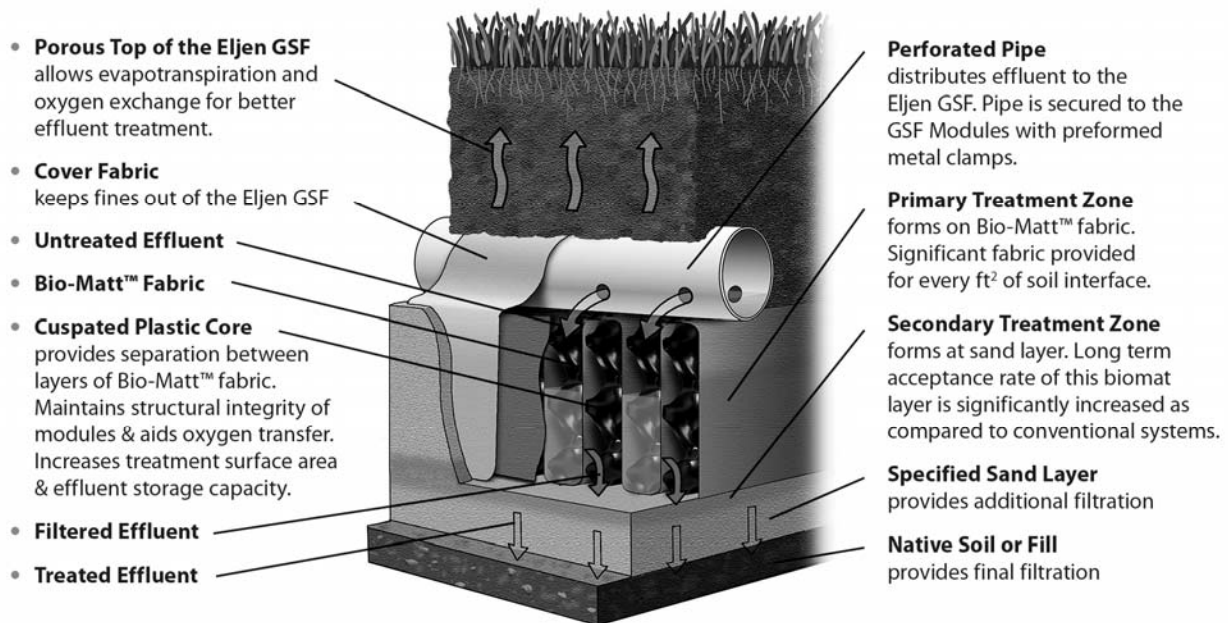

## 1.0 Conditions for Use

---

**1.0.1 ALTERATION OF MODULES:** GSF modules shall not be altered by cutting or any other type of physical modification.

**1.0.2 WATER SOFTENER BACKWASH:** Water softener backwash shall be discharged to a separate soil absorption field meeting all required state codes and local regulations.

**1.0.3 SEPTIC TANK OUTLET FILTERS:** Eljen requires the use of outlet filters on all tanks including single compartment tanks, up-sized tanks or when the dwelling has a garbage disposal installed.

**1.0.4 GARBAGE DISPOSALS:** Eljen discourages the use of garbage disposals with septic systems. If a GSF system is to be designed and installed with garbage disposals the following measures must be taken to prevent solids from leaving the tank and entering the GSF system:

- Increase the septic tank capacity by a minimum of 30% *or*
- Installation of a second septic tank installed in series if a multi-compartment tank isn't used

**1.0.5 ADDITIONAL FACTORS AFFECTING RESIDENTIAL SYSTEM SIZE:** Homes with expected higher than normal water usage may consider increasing the septic tank volume as well as incorporating a multiple compartment septic tank. Consideration for disposal area may be up-sized for expected higher than normal water use.

For example:

- Luxury homes, homes with a Jacuzzi style tubs, and other high use fixtures.
- Homes with known higher than normal occupancy.

## 1.1 System Design

---

**1.1.1 REQUIREMENTS:** GSF systems must meet the local rules and regulations except as outlined in this manual.

Please contact Eljen's Technical Resource Department at 1-800-444-1359 for design information on commercial systems.

**1.1.2 NUMBER OF GSF MODULES REQUIRED:** Systems can always be designed beyond the minimum required number of modules. The minimum design requirements per 150 gpd are 6 A42 modules.

**1.1.3 SUITABLE SITE AND SOIL CONDITIONS:** The Eljen Modules may be designed for all sites that meet the criteria of the local approving authority.

## 2.0 Trench Design and Installation

---

**2.0.1 ACCEPTABLE METHODS OF DISTRIBUTION:** Gravity, dosed and pressure distribution are acceptable.

**2.0.2 MINIMUM DEPTH FROM ORIGINAL GRADE:** The minimum depth for subsurface systems is determined by the local approving authority.

### 2.0.3 GENERAL CROSS SECTIONS

FIGURE 2: A42 TRENCH CROSS SECTION

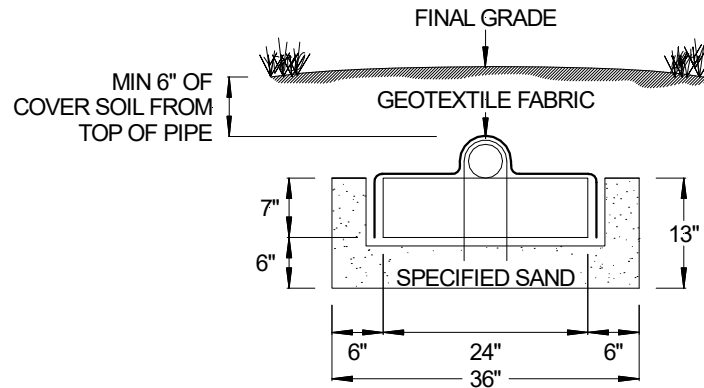

**All trenches are required to have a minimum of:**

- 6 inches of Specified Sand at the edges of the GSF module.
- 6 inches of Specified Sand at the beginning and end of each GSF Row.
- 6 inches of Specified Sand directly below the GSF module.
- 6 inches of cover soil material above the 4-inch distribution pipe.

**2.0.4 VERTICAL SEPARATION TO SEASONAL HIGH-WATER TABLE OR LIMITING LAYER:** Refer to the local regulations

**2.0.5 DISTRIBUTION BOX:** Parallel distribution is preferred. Sequential distribution may be utilized for sloping sites.

**2.0.6 PARALLEL DISTRIBUTION:** Parallel distribution is the preferred method of application to a gravity or pump to gravity system. It encourages equal flows to each of the lines in the system. It is recommended for most trench systems.

**2.0.7 TRENCH LENGTH:** The maximum gravity lateral run shall not exceed 100 feet and preferably should be less than 60 feet. If a lateral is supplied from the center, the total length shall not exceed 200 feet (100 feet to each side) and a maximum of 120 feet is preferred.

**2.0.8 EQUAL LENGTH:** Trenches must be of equal length in order to provide equal distribution.

**2.0.9 SPACING GUIDANCE BETWEEN TRENCHES AND SINGLE LATERAL BED ROWS:** Ensure trenches are of equal length throughout the system. Adjacent trenches should be separated by at least 6 feet of undisturbed soil.

**2.0.10 DISPERSAL AREA:** Dispersal area requirements are met by total length and width of each trench added together. Example: 3 trenches x 3 feet wide x 60 feet = 540 square feet of dispersal area.

**2.0.11 MINIMUM SLOPE REQUIREMENTS:** Maintain a 3:1 slope or gentler for all slopes off the cell area.

## 2.1 Trench Design Example

FIGURE 3: PLAN VIEW – TRENCH SYSTEM

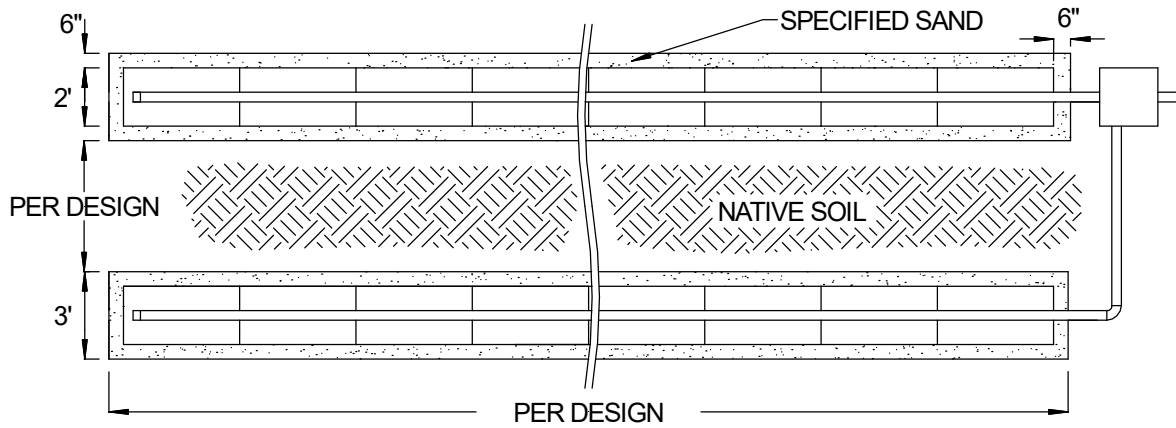

FIGURE 4: SECTION VIEW – TRENCH SYSTEM – LEVEL SITE

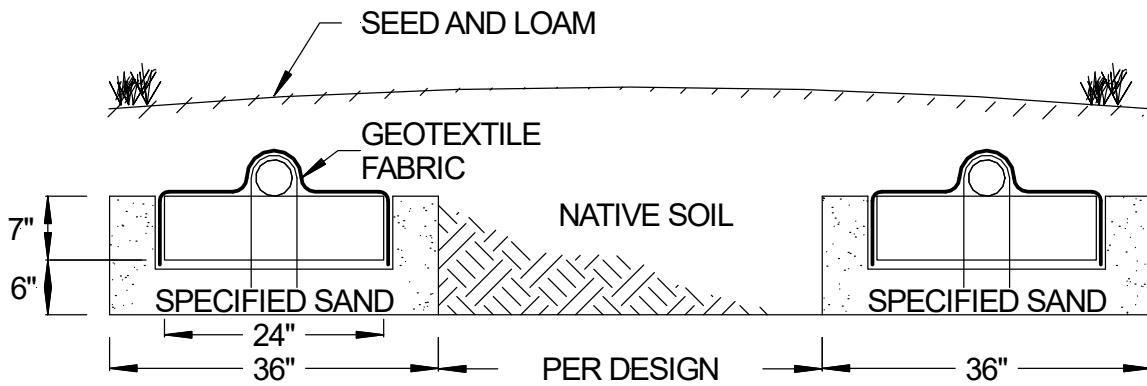
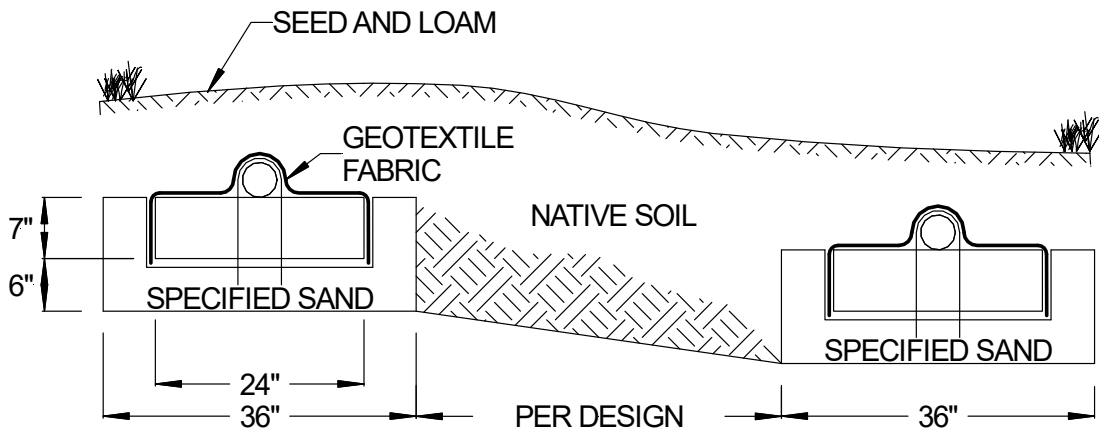

FIGURE 5: SECTION VIEW – TRENCH SYSTEM – SLOPING SITE



## 2.2 Trench Design Installation Steps

---

1. Ensure all components leading to the GSF system are installed properly. Septic tank effluent filters are required with the GSF system.
2. Determine the number of GSF Modules required.
3. Prepare the site. Do not install a system in saturated ground or wet soils that are smeared during excavation. Keep machinery off infiltrative areas.
4. Plan all drainage requirements above (up-slope) of the system. Set soil grades to ensure that storm water drainage and ground water is diverted away from the absorption area once the system is complete.
5. Excavate the trench; scarify the receiving layer to maximize the interface between the native soil and specified sand.
6. Minimize walking in the trench prior to placement of the specified sand to avoid soil compaction.
7. Place specified sand in a 6" lift, stabilize by foot, a hand-held tamping tool or a portable vibrating compactor. The stabilized height below the GSF module must be level at 6".
8. Place GSF modules with **PAINTED STRIPE FACING UP**, end to end on top of the specified sand along their 4-foot length.
9. A standard 4-inch perforated pipe, SDR 35 or equivalent, is centered along the modules 4-foot length. Orifices are set at the 4 & 8 o'clock position.
10. All 4-inch pipes are secured with manufacturers supplied wire clamps, one per module.
11. (Pressure Distribution Systems) The pressure pipe orifices are set at the 12 o'clock position as shown in Figure 16. Orifice shields are placed over the lateral. Each pressure lateral will have a drain hole at the 6 o'clock position. Each pressure lateral shall have a clean out at the end of the trench. Refer to Section 7 for guidelines on how to use pressure distribution.
12. **Cover fabric substitution is not allowed.** The installer should lay the Eljen provided geotextile cover fabric lengthwise down the trench, with the fabric fitted to the perforated pipe on top of the GSF modules. Fabric should be neither too loose, nor too tight. The correct tension of the cover fabric is set by:
  - a. Spreading the cover fabric over the top of the module and down both sides of the module with the cover fabric tented over the top of the perforated distribution pipe.
  - b. Place shovelfuls of Specified Sand directly over the pipe area allowing the cover fabric to form a mostly vertical orientation along the sides of the pipe. Repeat this step moving down the pipe.
13. Place 6 inches of Specified Sand along both sides of the modules edge. A minimum of 6 inches of Specified Sand is placed at the beginning and end of each trench.
14. Complete backfill with a minimum of 6 inches of approved cover material measured from the top of the distribution pipe. Backfill exceeding 18 inches over the top of the unit requires venting at the far end of the trench. Use well graded native soil fill that is clean, porous and devoid of large rocks. Do not use wheeled equipment over the system. A light track machine may be used with caution, avoiding crushing or shifting of pipe assembly.
15. Divert surface runoff from the system. Finish grade to prevent surface ponding. Topsoil and seed system area to protect from erosion.



## 3.0 Bed Design and Installation

---

**3.0.1 ACCEPTABLE METHODS OF DISTRIBUTION:** Gravity, dosed and pressure distribution are acceptable.

**3.0.2 MINIMUM DEPTH FROM ORIGINAL GRADE:** The minimum depth for subsurface systems is determined by the local approving authority.

### 3.0.3 GENERAL CROSS SECTION

FIGURE 6: BED CROSS SECTION

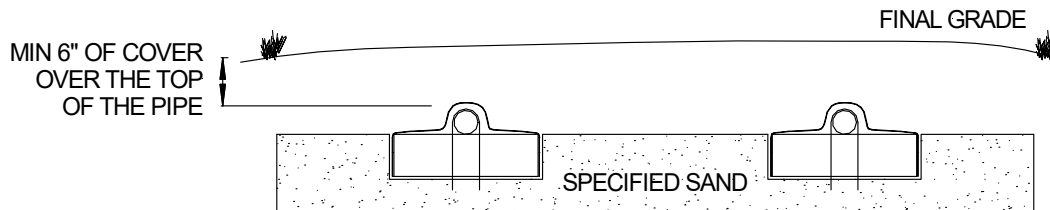

**All bed systems are required to have a minimum of:**

- 6 inches of Specified Sand at the edges of the GSF module.
- 6 inches of Specified Sand at the beginning and end of each GSF Row.
- 6 inches of Specified Sand directly below the GSF module.
- 6 inches of cover soil material above the 4-inch distribution pipe

**3.0.4 VERTICAL SEPARATION TO SEASONAL HIGH-WATER TABLE OR LIMITING LAYER:** Refer to the local regulations

**3.0.5 DISTRIBUTION BOX:** Parallel distribution is preferred. Sequential distribution may be utilized for sloping sites.

**3.0.6 PARALLEL DISTRIBUTION:** Parallel distribution is the preferred method of application to a gravity or pump to gravity system. It encourages equal flows to each of the lines in the system. It is recommended for most bed systems.

**3.0.7 ROWS REQUIRED:** All bed systems shall have a minimum of one row of modules. Typical bed installations require 2 rows of modules.

**3.0.8 ROW LENGTH:** The maximum gravity lateral run shall not exceed 100 feet and preferably should be less than 60 feet. If a lateral is supplied from the center, the total length shall not exceed 200 feet (100 feet to each side) and a maximum of 120 feet is preferred.

**3.0.9 EQUAL LENGTH:** Rows must be of equal length in order to provide equal distribution.

**3.0.10 DISPERSAL AREA:** Dispersal area requirements are met by total length and width of the bed. Example: 12 feet wide x 60 feet = 720 square feet of dispersal area.

**3.0.11 MINIMUM SLOPE REQUIREMENTS:** Maintain a 3:1 slope or gentler for all slopes off the cell area.

**3.0.12 SYSTEM LENGTH AND WIDTH:** Best engineering practices should be used when constructing the bed systems. Eljen recommends the dimensions of the bed shall be as long and narrow as the site allows.

**3.0.13 BED DESIGN:** Evenly distribute the bed laterals in the basal area. A minimum separation distance between laterals for A42's is 3 feet.

### 3.1 Bed Design Example

FIGURE 7: PLAN VIEW – BED SYSTEM

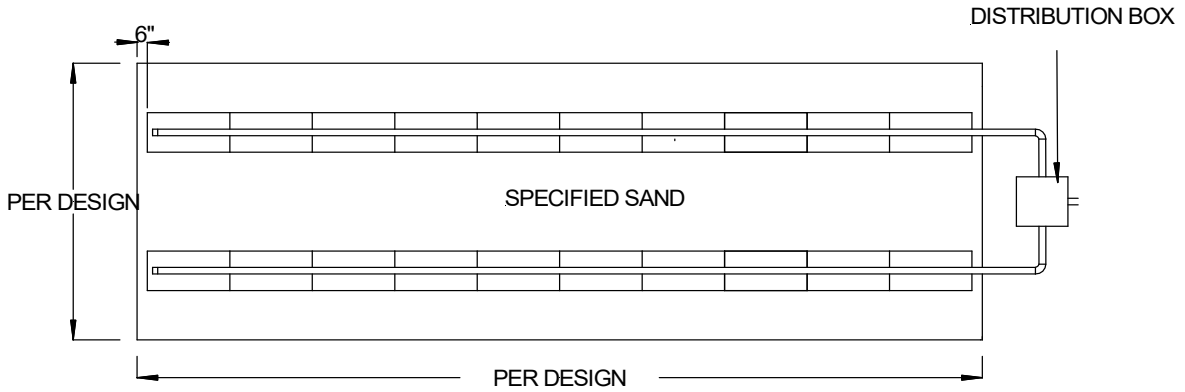

FIGURE 8: SECTION VIEW – 2 LATERAL BED SYSTEM

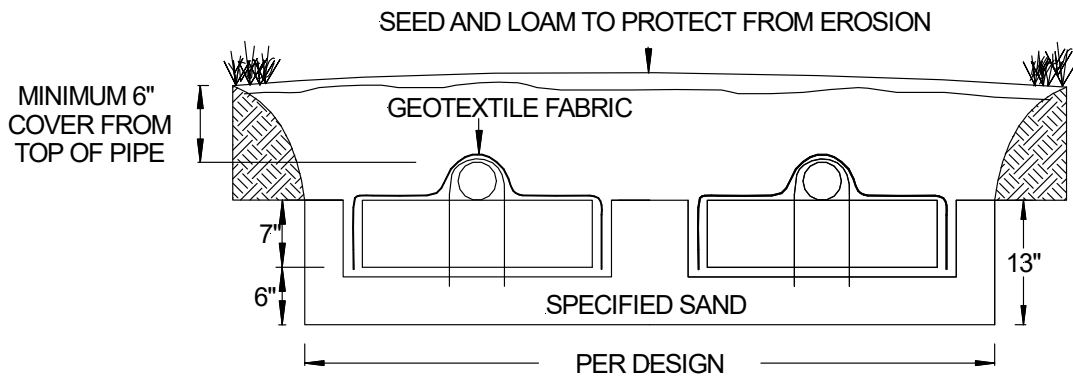
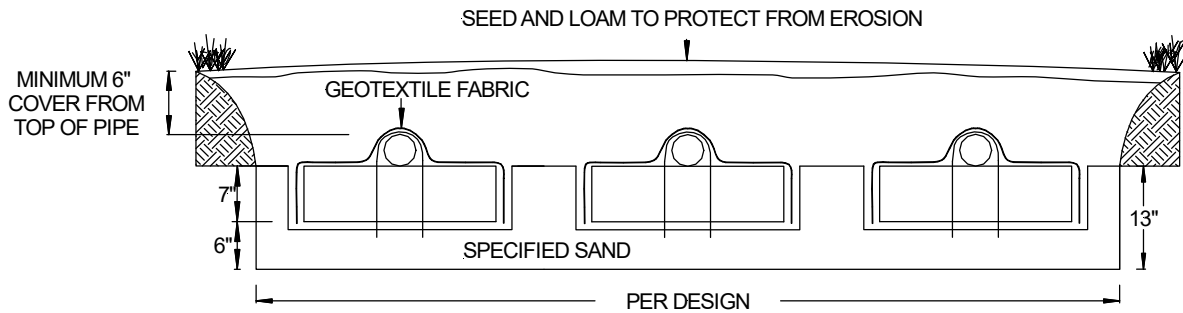

FIGURE 9: SECTION VIEW – 3 LATERAL BED SYSTEM



## 3.2 Bed Design Installation Steps

---

1. Ensure all components leading to the GSF system are installed properly. Septic tank effluent filters are required with the GSF system.
2. Determine the number of GSF Modules required.
3. Prepare the site. Do not install a system in saturated ground or wet soils that are smeared during excavation. Keep machinery off infiltrative areas.
4. Plan all drainage requirements above (up-slope) of the system. Set soil grades to ensure that storm water drainage and ground water is diverted away from the absorption area once the system is complete.
5. Excavate the bed absorption area; scarify the receiving layer to maximize the interface between the native soil and specified sand.
6. Minimize walking in the absorption area prior to placement of the specified sand to avoid soil compaction.
7. Place specified sand in a 6" lift, stabilize by foot, a hand-held tamping tool or a portable vibrating compactor. The stabilized height below the GSF module must be level at 6".
8. Place GSF modules with **PAINTED STRIPE FACING UP**, end to end on top of the specified sand along their 4-foot length.
9. A standard 4-inch perforated pipe, SDR 35 or equivalent, is centered along the modules 4-foot length. Orifices are set at the 4 & 8 o'clock position.
10. All 4-inch pipes are secured with manufacturers supplied wire clamps, one per module.
11. (Pressure Distribution Systems) The pressure pipe orifices are set at the 12 o'clock position as shown in Figure 16. Orifice shields are placed over the lateral. Each pressure lateral will have a drain hole at the 6 o'clock position. Each pressure lateral shall have a clean out at the end of the trench. Refer to Section 7 for guidelines on how to use pressure distribution.
12. **Cover fabric substitution is not allowed.** The installer should lay the Eljen provided geotextile cover fabric lengthwise down the row, with the fabric fitted to the perforated pipe on top of the GSF modules. Fabric should be neither too loose, nor too tight. The correct tension of the cover fabric is set by:
  - a. Spreading the cover fabric over the top of the module and down both sides of the module with the cover fabric tented over the top of the perforated distribution pipe.
  - b. Place shovelfuls of Specified Sand directly over the pipe area allowing the cover fabric to form a mostly vertical orientation along the sides of the pipe. Repeat this step moving down the pipe.
13. Place 6 inches of Specified Sand along both sides of the modules edge. A minimum of 6 inches of Specified Sand is placed at the beginning and end of each module row. A minimum of 12 inches of Specified Sand is placed in between module rows.
14. Complete backfill with a minimum of 6 inches of approved cover material measured from the top of the distribution pipe. Backfill exceeding 18 inches over the top of the unit requires venting at the far end of the bed. Use well graded native soil fill that is clean, porous and devoid of large rocks. Do not use wheeled equipment over the system. A light track machine may be used with caution, avoiding crushing or shifting of pipe assembly.
15. Divert surface runoff from the system. Finish grade to prevent surface ponding. Topsoil and seed system area to protect from erosion.

## 4.0 Level Above Grade Design and Installation

**4.0.1 ACCEPTABLE METHODS OF DISTRIBUTION:** Pump to gravity and pressure distribution are acceptable.

### 4.0.2 GENERAL CROSS SECTION

FIGURE 10: LEVEL ABOVE GRADE CROSS SECTION

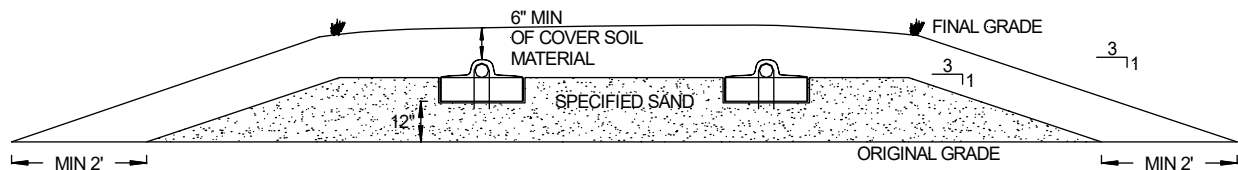

**All level above grade systems are required to have a minimum of:**

- 6 inches of Specified Sand at the edges of the GSF module.
- 6 inches of Specified Sand at the beginning and end of each GSF Row.
- 12 inches of Specified Sand directly below the GSF module.
- 6 inches of cover soil material above the 4-inch distribution pipe

**4.0.3 VERTICAL SEPARATION TO SEASONAL HIGH-WATER TABLE OR LIMITING LAYER:** Refer to the local regulations

**4.0.4 DISTRIBUTION BOX:** Parallel distribution is preferred. Sequential distribution may be utilized for sloping sites.

**4.0.5 PARALLEL DISTRIBUTION:** Parallel distribution is the preferred method of application to a gravity or pump to gravity system. It encourages equal flows to each of the lines in the system. It is recommended for most bed systems.

**4.0.6 ROWS REQUIRED:** All bed systems shall have a minimum of one row of modules. Typical bed installations require 2 rows of modules.

**4.0.7 ROW LENGTH:** The maximum gravity lateral run shall not exceed 100 feet and preferably should be less than 60 feet. If a lateral is supplied from the center, the total length shall not exceed 200 feet (100 feet to each side) and a maximum of 120 feet is preferred.

**4.0.8 EQUAL LENGTH:** Rows must be of equal length in order to provide equal distribution.

**4.0.9 DISPERSAL AREA:** Dispersal area requirements are met by total length and width of the sand on the cell area. This includes the sand extensions from the Eljen Cell area. Example:

Cell Area: 10 feet x 61 feet

Sand Extensions: 6 feet

$(2 \times \text{Sand Extensions} + \text{width}) \times (2 \times \text{Sand Extensions} + \text{Length})$

$(2 \times 6 + 10) \times (2 \times 6 + 61) = 1,606$  square feet of dispersal area.

## 4.0 Level Above Grade Design and Installation

---

**4.0.10 MINIMUM SLOPE REQUIREMENTS:** Maintain a 3:1 slope or gentler for all slopes off the cell area.

**4.0.11 SYSTEM LENGTH AND WIDTH:** Best engineering practices should be used when constructing the bed systems. Eljen recommends the dimensions of the bed shall be as long and narrow as the site allows.

**4.0.12 BED DESIGN:** Evenly distribute the bed laterals in the cell area. A minimum separation distance between laterals for A42's is 3 feet.

## 4.1 Level Above Grade Design Example

---

FIGURE 11: PLAN VIEW – BED SYSTEM – LEVEL SITE

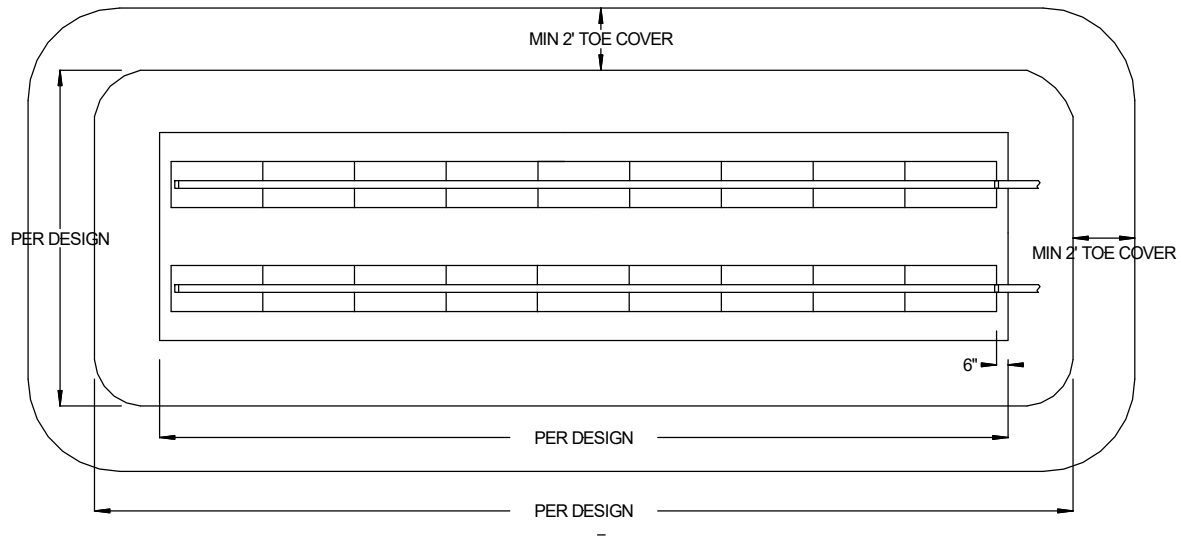
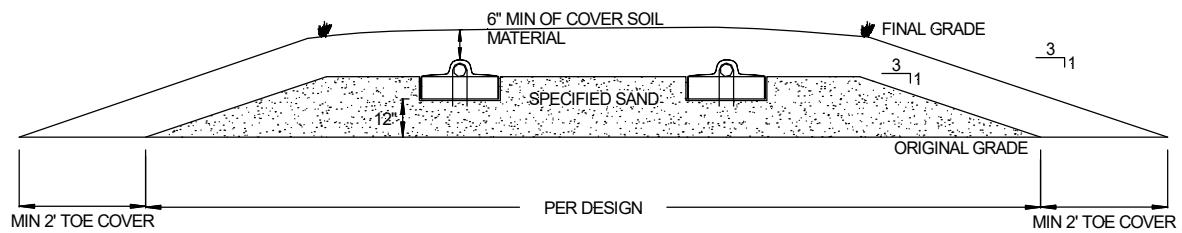

FIGURE 12: CROSS SECTION VIEW – BED SYSTEM – LEVEL SITE



## 4.2 Level Above Grade Installation Steps

---

1. Ensure all components leading to the GSF system are installed properly. Septic tank effluent filters are required with the GSF system.
2. Determine the above grade system dimensions.
3. Prepare the site. Do not install a system in saturated ground or wet soils that are smeared during excavation. Keep machinery off infiltrative areas.
4. Plan all drainage requirements above (up-slope) of the system. Set soil grades to ensure that storm water drainage and ground water is diverted away from the system once it is complete.
5. Scarify the basal layer to maximize the interface between the native soil and Specified Sand. Minimize walking on the receiving layer prior to placement of the Specified Sand.
6. Place Specified Sand in two 6-inch lifts, stabilize after each lift. The minimum stabilized height below the GSF module must be level at 12 inches. All the sand used in the construction of the system components must be **ASTM C-33 Sand**. See Table 1 for more information on the sand and sieve specifications.
7. Place GSF modules with **PAINTED STRIPE FACING UP**, end to end on top of the specified sand along their 4-foot length.
8. A standard 4-inch perforated pipe, SDR 35 or equivalent, is centered along the modules 4-foot length. Orifices are set at the 4 & 8 o'clock position.
9. All 4-inch pipes are secured with manufacturers supplied wire clamps, one per module.
10. (Pressure Distribution Systems) The pressure pipe orifices are set at the 12 o'clock position as shown in Figure 16. Orifice shields are placed over the lateral. Each pressure lateral will have a drain hole at the 6 o'clock position. Each pressure lateral shall have a clean out at the end of the trench. Refer to Section 7 for guidelines on how to use pressure distribution.
11. **Cover fabric substitution is not allowed.** The installer should lay the Eljen provided geotextile cover fabric lengthwise down the row, with the fabric fitted to the perforated pipe on top of the GSF modules. Fabric should be neither too loose, nor too tight. The correct tension of the cover fabric is set by:
  - a. Spreading the cover fabric over the top of the module and down both sides of the module with the cover fabric tented over the top of the perforated distribution pipe.
  - b. Place shovelfuls of Specified Sand directly over the pipe area allowing the cover fabric to form a mostly vertical orientation along the sides of the pipe. Repeat this step moving down the pipe.
12. Place 6 inches of Specified Sand along both sides of the modules edge. A minimum of 6 inches of Specified Sand is placed at the beginning and end of each module row. A minimum of 12 inches of Specified Sand is placed in between module rows.
13. Complete backfill with a minimum of 6 inches of approved cover material measured from the top of the distribution pipe. Backfill exceeding 18 inches over the top of the unit requires venting at the far end of the bed. Use well graded native soil fill that is clean, porous and devoid of large rocks. Do not use wheeled equipment over the system. A light track machine may be used with caution, avoiding crushing or shifting of pipe assembly.
14. Divert surface runoff from the system. Finish grade to prevent surface ponding. Topsoil and seed system area to protect from erosion.

## 5.0 Sloped Above Grade Bed Design and Installation

**5.0.1 ACCEPTABLE METHODS OF DISTRIBUTION:** Pump to gravity and pressure distribution are acceptable.

### 5.0.2 GENERAL CROSS SECTION

FIGURE 13: SLOPED ABOVE GRADE BED CROSS SECTION

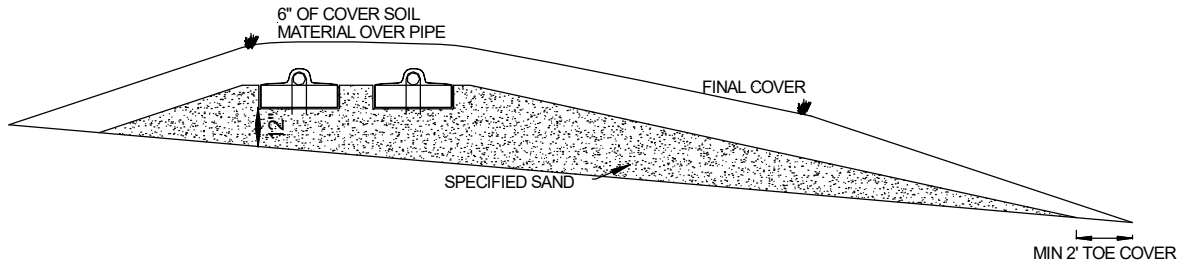

**All sloped above grade bed systems are required to have a minimum of:**

- 6 inches of Specified Sand at the edges of the GSF module.
- 6 inches of Specified Sand at the beginning and end of each GSF Row.
- 12 inches of Specified Sand directly below the GSF module.
- 6 inches of cover soil material above the 4-inch distribution pipe

**5.0.3 VERTICAL SEPARATION TO SEASONAL HIGH-WATER TABLE OR LIMITING LAYER:** Refer to the local regulations

**5.0.4 DISTRIBUTION BOX:** Parallel distribution is preferred. Sequential distribution may be utilized for sloping sites.

**5.0.5 PARALLEL DISTRIBUTION:** Parallel distribution is the preferred method of application to a gravity or pump to gravity system. It encourages equal flows to each of the lines in the system. It is recommended for most bed systems.

**5.0.6 ROW LENGTH:** The maximum gravity lateral run shall not exceed 100 feet and preferably should be less than 60 feet. If a lateral is supplied from the center, the total length shall not exceed 200 feet (100 feet to each side) and a maximum of 120 feet is preferred.

**5.0.7 ROWS REQUIRED:** All bed systems shall have a minimum of one row of modules. Typical bed installations require 2 rows of modules.

**5.0.8 EQUAL LENGTH:** Rows must be of equal length in order to provide equal distribution.

**5.0.9 DISPERSAL AREA:** Dispersal area requirements are met by total cell length and cell width plus downslope sand. Example:

Cell Area: 10 feet x 61 feet

Downslope Sand Extensions: 6 feet

Total Cell Length x (Total Cell Width + Downslope Sand Extension)

61 ft x (10 ft + 6 ft) = 976 square feet of dispersal area.



## 5.0 Sloped Above Grade Bed Design and Installation

---

**5.0.10 MINIMUM SLOPE REQUIREMENTS:** Maintain a 3:1 slope or gentler for all slopes off the cell area.

**5.0.11 SYSTEM LENGTH AND WIDTH:** Best engineering practices should be used when constructing the bed systems. Eljen recommends the dimensions of the bed shall be as long and narrow as the site allows.

**5.0.12 BED DESIGN:** Evenly distribute the bed laterals in the cell area. A minimum separation distance between laterals for A42's is 3 feet.

**5.0.13 UPSLOPE SAND:** In **NO** circumstances on sloping sites with greater than 0.5% slope shall the upslope sand contribute or be counted towards the basal area.

## 5.1 Sloped Above Grade Bed Design Example

---

FIGURE 14: PLAN VIEW – BED SYSTEM –SLOPING SITE

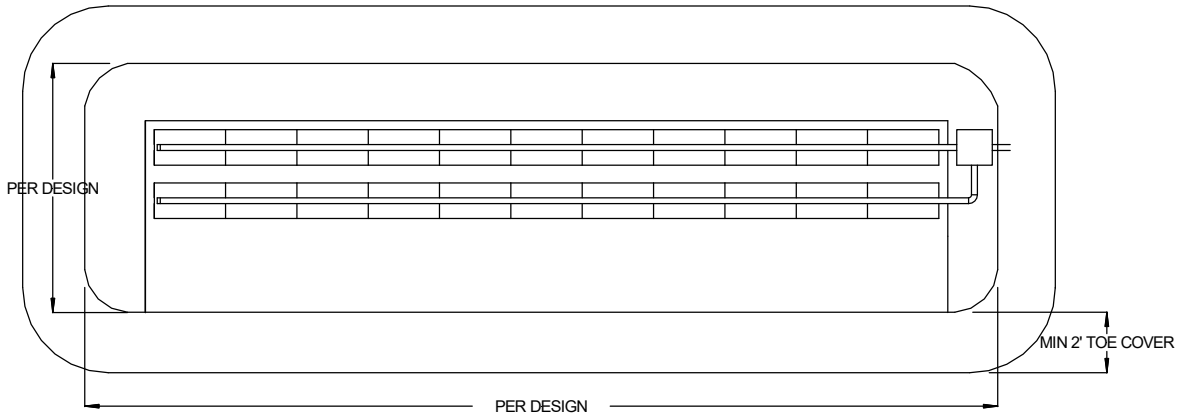
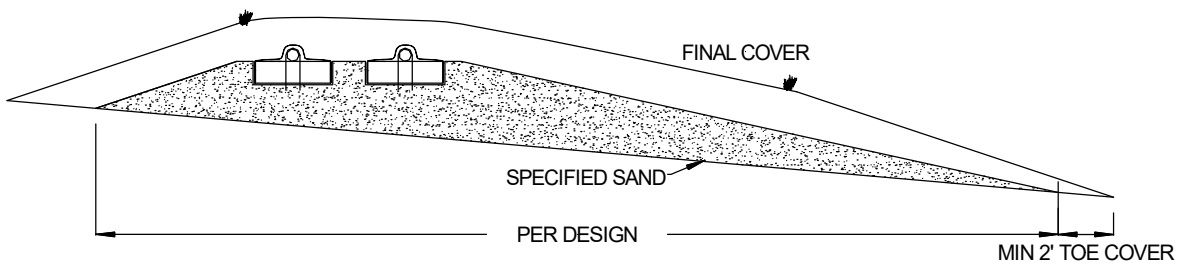

FIGURE 15: CROSS SECTION VIEW –BED SYSTEM – SLOPING SITE



## 5.2 Sloped Above Grade Design Installation Steps

---

1. Ensure all components leading to the GSF system are installed properly. Septic tank effluent filters are required with the GSF system.
2. Determine the above grade system dimensions.
3. Prepare the site. Do not install a system in saturated ground or wet soils that are smeared during excavation. Keep machinery off infiltrative areas.
4. Plan all drainage requirements above (up-slope) of the system. Set soil grades to ensure that storm water drainage and ground water is diverted away from the system once it is complete.
5. Scarify the basal layer to maximize the interface between the native soil and Specified Sand. Minimize walking on the receiving layer prior to placement of the Specified Sand.
6. Place Specified Sand in two 6-inch lifts, stabilize after each lift. The minimum stabilized height below the GSF module must be level at 12 inches. All the sand used in the construction of the system components must be **ASTM C-33 Sand**. See Table 1 for more information on the sand and sieve specifications.
7. Place GSF modules with **PAINTED STRIPE FACING UP**, end to end on top of the specified sand along their 4-foot length.
8. A standard 4-inch perforated pipe, SDR 35 or equivalent, is centered along the modules 4-foot length. Orifices are set at the 4 & 8 o'clock position.
9. All 4-inch pipes are secured with manufacturers supplied wire clamps, one per module.
10. (Pressure Distribution Systems) The pressure pipe orifices are set at the 12 o'clock position as shown in Figure 16. Orifice shields are placed over the lateral. Each pressure lateral will have a drain hole at the 6 o'clock position. Each pressure lateral shall have a clean out at the end of the trench. Refer to Section 7 for guidelines on how to use pressure distribution.
11. **Cover fabric substitution is not allowed.** The installer should lay the Eljen provided geotextile cover fabric lengthwise down the row, with the fabric fitted to the perforated pipe on top of the GSF modules. Fabric should be neither too loose, nor too tight. The correct tension of the cover fabric is set by:
  - a. Spreading the cover fabric over the top of the module and down both sides of the module with the cover fabric tented over the top of the perforated distribution pipe.
  - b. Place shovelfuls of Specified Sand directly over the pipe area allowing the cover fabric to form a mostly vertical orientation along the sides of the pipe. Repeat this step moving down the pipe.
12. Place 6 inches of Specified Sand along both sides of the modules edge. A minimum of 6 inches of Specified Sand is placed at the beginning and end of each module row. A minimum of 12 inches of Specified Sand is placed in between module rows.
13. Complete backfill with a minimum of 6 inches of approved cover material measured from the top of the distribution pipe. Backfill exceeding 18 inches over the top of the unit requires venting at the far end of the bed. Use well graded native soil fill that is clean, porous and devoid of large rocks. Do not use wheeled equipment over the system. A light track machine may be used with caution, avoiding crushing or shifting of pipe assembly.
14. Divert surface runoff from the system. Finish grade to prevent surface ponding. Topsoil and seed system area to protect from erosion.

## 6.0 Dosing Distribution Requirements

---

**DOSING DESIGN CRITERIA:** Dosing volume must be set to deliver a maximum of **3 gallons per Module** per dosing cycle. Head loss and drain back volume must be considered in choosing the pump size and force main diameter.

## 7.0 Pressure Distribution Requirements

---

**7.0.1 PRESSURE DISTRIBUTION:** Place 1.5-inch SCH-40 pressure distribution pipe centered along the modules 4-foot length.

Orifices are set at the 12 o'clock position into an orifice shield device. Orifice size will be no smaller than 1/8 inch. Hole size is determined by dividing the selected pump flow rate by the number of holes, then looking up the diameter required for that flow per hole at the squirt height resulting from the residual head of the pump. Orifices shields will be placed over the orifices.

Each pressure lateral will have a drain hole at the 6 o'clock position.

Each pressure lateral shall include sweeping cleanouts at the terminal ends and be accessible from grade.

Secure pipe to GSF modules with provided wire clamps, one clamp per Eljen module.

**7.0.2 DOSING DESIGN CRITERIA:** For all pump systems; use a maximum of 3 gallons per dose per A42 module in the system. Adjust pump flow and run time to achieve the above maximum dose. Use a minimum pump run time of one minute. Longevity of currently available effluent pumps is not affected by shorter run times. Choose force main diameter to minimize percentage of dose drain back.

FIGURE 16: PRESSURE CLEAN OUT

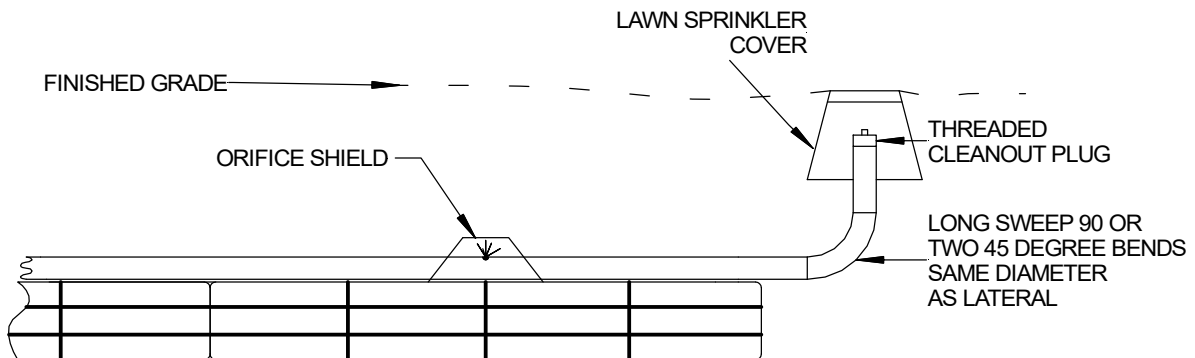

## 7.0 Pressure Distribution Requirements

---

FIGURE 17: CONTOURED TRENCH PRESSURE DISTRIBUTION

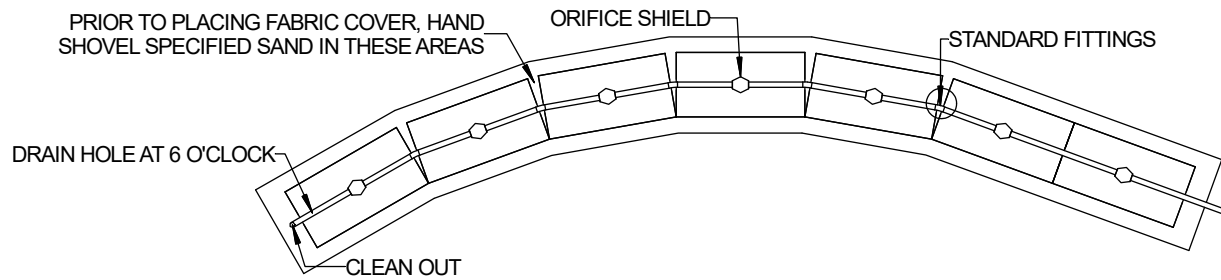

GSF Pressure Distribution trench placed on a contour or winding trenches to maintain horizontal separation distances.

## 8.0 Pump Controls

---

Pump controlled systems will include an electrical control system that has the alarm circuit independent of the pump circuit controls and components that are listed by UL or equivalent, is located outside, within line of sight of the dosing tank and is secure from tampering and resistant to weather (minimum of NEMA4X).

The control panel shall be equipped with both audible and visual high liquid level alarms installed in a conspicuous location. Float switches shall be mounted independent of the pump and force main so that they can be easily replaced and/or adjusted without removing the pump.

## 9.0 System Ventilation

---

**9.0.1 SYSTEM VENTILATION:** Air vents are required on all absorption systems located with *more than 18 inches of cover material* as measured from the top of the GSF module to finished grade. This will ensure proper aeration of the modules and sand filter. The GSF Module has aeration channels inside the physical unit and in between the rows of GSF modules. Under normal operating conditions, only a fraction of the filter is in use. The unused channels remain open for intermittent peak flows and the transfer of air. The extension of the distribution pipe to the vent provides adequate delivery of air into the GSF system.

Typically, home plumbing operates under negative pressure due to hot water heating the pipes and reducing the density of air in the house vent. As hot air rises and exits the home, it must be replaced by air from the GSF. To maintain this airflow and fully aerate the GSF system, it is important that air vents are located only on the distal end of the GSF pipe network.

**9.0.2 VENTILATION PLACEMENT:** In a GSF system, the vent is usually a 4-inch diameter pipe extended to a convenient location behind shrubs, as shown below. The pipe must have an invert higher than the system so that it does not drain effluent.

FIGURE 18: GSF WITH 4" VENT EXTENDED TO CONVENIENT LOCATION

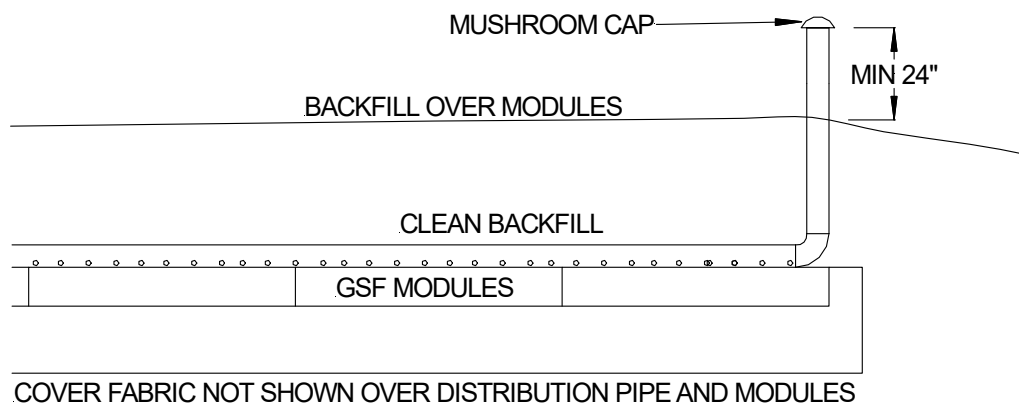

## **COMPANY HISTORY**

Established in 1970, Eljen Corporation created the world's first prefabricated drainage system for foundation drainage and erosion control applications. In the mid-1980s, we introduced our Geotextile Sand Filter products for the passive advanced treatment of onsite wastewater in both residential and commercial applications. Today, Eljen is a global leader in providing innovative products and solutions for protecting our environment and public health.

## **COMPANY PHILOSOPHY**

Eljen Corporation is committed to advancing the onsite industry through continuous development of innovative new products, delivering high quality products and services to our customers at the best price, and building lasting partnerships with our employees, suppliers, and customers.



90 Meadow Road, Windsor, CT 06095 • Tel: 800-444-1359 • Fax: 860-610-0427

**[www.eljen.com](http://www.eljen.com)**

