



**Geotextile Sand Filter**

Rhode Island  
Design & Installation Manual



**eljen**  
CORPORATION

*Innovative Onsite Products & Solutions Since 1970*

July 2021  
[www.eljen.com](http://www.eljen.com)

# Table of Contents

---

SUBJECT	PAGE
GLOSSARY OF TERMS.....	3
GSF SYSTEM DESCRIPTION .....	4
1.0 DESIGN AND INSTALLATION .....	5
2.0 TRENCH INSTALLATION SIZING AND GUIDELINES.....	9
3.0 ELEVATED TRENCH GUIDELINES .....	14
4.0 DOSING DISTRIBUTION GUIDANCE .....	15
5.0 PRESSURE DISTRIBUTION GUIDANCE.....	16
6.0 PUMP CONTROLS.....	17
7.0 SYSTEM VENTILATION.....	17
8.0 GSF INSPECTION CHECK LIST .....	20
GSF DRAWINGS AND TABLES	
DRAWINGS	
FIGURE 1: GSF SYSTEM OPERATION .....	4
FIGURE 2: TYPICAL B43 GSF CROSS SECTION.....	5
FIGURE 3: CROSS OVER DESIGN.....	7
FIGURE 4: PLAN VIEW – 600 GPD – TRENCH SYSTEM .....	9
FIGURE 5: PLAN VIEW – 600 GPD – TRENCH SYSTEM .....	10
FIGURE 6: PLAN VIEW – TRENCH SYSTEM – LEVEL SITE.....	11
FIGURE 7: SECTION VIEW – TRENCH SYSTEM – LEVEL SITE.....	11
FIGURE 8: PLAN VIEW – TRENCH SYSTEM – SLOPING SITE.....	12
FIGURE 9: SECTION VIEW – TRENCH SYSTEM – SLOPING SITE .....	12
FIGURE 10: SECTION VIEW – ELEVATED TRENCH SYSTEM .....	15
FIGURE 11: PRESSURE PIPE PLACEMENT .....	16
FIGURE 12: PRESSURE CLEAN OUT .....	16
FIGURE 13: CONTOURED TRENCH PRESSURE DISTRIBUTION.....	17
FIGURE 14: GRAVITY VENTING.....	18
FIGURE 15: AIR BY-PASS LINE.....	18
FIGURE 16: PRESSURE CLEAN OUT PRESSURE DOSED SYSTEMS.....	19
FIGURE 17: GSF WITH 4” VENT EXTENDED TO CONVENIENT LOCATION .....	19
TABLES	
TABLE 1: SPECIFIED SAND SIEVE REQUIREMENTS.....	3
TABLE 2: ELJEN B43 GSF SYSTEM SIZING.....	8

## Glossary of Terms

---

<b>B43 Module</b>	48" x 36" x 7" (L x W x H)
<b>Cover Fabric</b>	The geotextile cover fabric (provided by manufacturer) that is placed over the GSF modules.
<b>Design Flow</b>	The estimated peak flow that is used to size a GSF system is 115 gallons per day per bedroom.
<b>Distribution Box</b>	A plastic or concrete box that receives effluent from a septic tank and splits the flow to pipes placed above the GSF modules. For equal distribution, the outlet pipe orifices are typically set at the same elevation to equalize the flow to each line.
<b>Flow Dial/Equalizer</b>	Special insert placed in the end of distribution pipes within the distribution box to compensate for possible unlevelled installation and promote favorable flow to the distribution pipes.
<b>GSF</b>	The Eljen Geotextile Sand Filter Modules and the 6-inch sand layer at the base and 6 inches along the sides of the modules.
<b>GSF Module</b>	The individual module of a GSF system. The module is comprised of a cusped plastic core and corrugated geotextile fabric.
<b>Specified Sand</b>	To ensure proper system operation, the system must be installed using ASTM C33 sand with less than 10% passing a #100 sieve and less than 5% passing a #200 sieve. Listed below is a chart outlining the sieve requirements for the Specified Sand. Ask your material supplier for a sieve analysis to verify that your material meets the required specifications.

**TABLE 1: SPECIFIED SAND SIEVE REQUIREMENTS**

<b>ASTM C33 Sand Specification</b>		
Sieve Size	Sieve Square Opening Size	Specification Percent Passing (Wet Sieve)
3/8 inch	9.52 mm	100
No. 4	4.76 mm	95 - 100
No. 8	2.38 mm	80 - 100
No. 16	1.19 mm	50 - 85
No. 30	590 µm	25 - 60
No. 50	297 µm	5 - 30
No. 100	149 µm	0 - 10
No. 200	75 µm	0 - 5

# GSF System Description

## Primary Treatment Zone

- Perforated pipe is centered above the GSF module to distribute septic effluent over and into corrugations created by the cusped core of the geotextile module.
- Septic effluent is filtered through the Bio-Matt fabric. The module's unique design provides increased surface area for biological treatment that greatly exceeds the module's footprint.
- Open air channels within the module support aerobic bacterial growth on the modules geotextile fabric interface, surpassing the surface area required for traditional absorption systems.
- An anti-siltation geotextile fabric covers the top and sides of the GSF module and protects the Specified Sand and soil from clogging, while maintaining effluent storage within the module.

## Secondary Treatment Zone

- Effluent drips into the Specified Sand layer and supports unsaturated flow into the native soil. This Specified Sand/soil interface maintains soil structure, thereby maximizing the available absorption interface in the native soil. The Specified Sand supports nitrification of the effluent, which reduces oxygen demand in the soil, thus minimizing soil clogging from anaerobic bacteria.
- The Specified Sand layer also protects the soil from compaction and helps maintain cracks and crevices in the soil. This preserves the soil's natural infiltration capacity, which is especially important in finer textured soils, where these large channels are critical for long-term performance.
- Native soil provides final filtration and allows for groundwater recharge.

FIGURE 1: GSF SYSTEM OPERATION

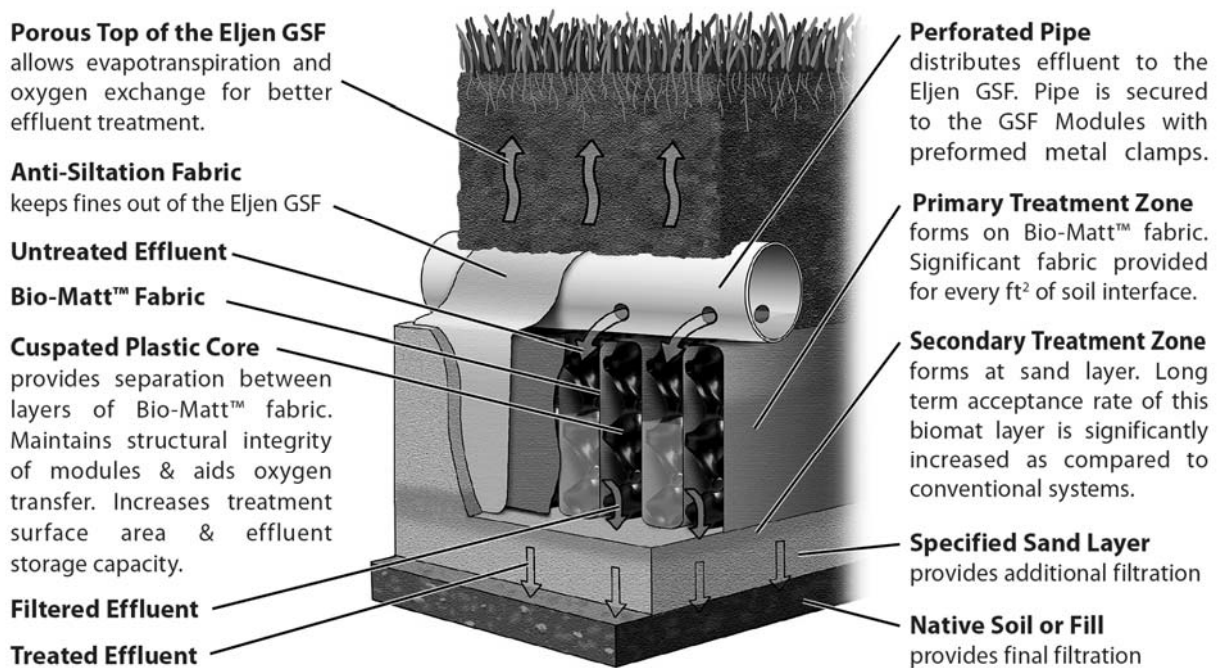

## 1.0 Design and Installation

FIGURE 2: TYPICAL B43 GSF CROSS SECTION

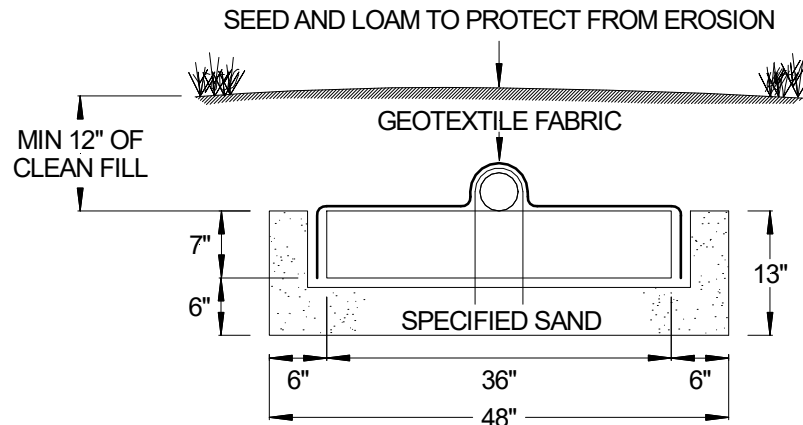

B43 MODULE (L x W x H) 48" x 36" x 7"

**All Systems are Required to Have a Minimum of:**

- 6 inches of Specified Sand is at the edges of the GSF module.
- 6 inches of Specified Sand is at the beginning and end of each GSF Row.
- 6 inches of Specified Sand is directly below the GSF module.
- Minimum 12 inches of \*clean fill above the module.

*\*NOTE: Clean fill above the units can be native material meeting the requirements of RI DEM OWTS Rule 6.330, ASTM C33 sand, or RIDEM specified gravel per OWTS Rule 6.33M.*

**1.1 REQUIREMENTS:** GSF systems must meet the local rules and regulations except as outlined in this manual. The Rhode Island Department of Environmental Management Rules Establishing Minimum Standards Relating to Location, Design, Construction and Maintenance of Onsite Wastewater Treatment Systems and the local regulations will be referred to as the *Guidelines* in this manual. System design examples shown in this manual apply to residential systems only. Please contact Eljen's Technical Resource Department at 1-800-444-1359 for design information on commercial systems.

**1.2 SPECIFIED SAND SPECIFICATION FOR GSF SYSTEMS:** The first 6 inches of sand immediately under, between rows and around the perimeter of the GSF system must be an **ASTM C33 WASHED CONCRETE SAND WITH LESS THAN 10% PASSING A #100 SIEVE AND LESS THAN 5% PASSING A #200 SIEVE**. Please place a prominent note to this effect on each design drawing. See Table 1 for more information on the ASTM C33 sand and sieve specifications.

**1.3 GRAVEL:** If necessary, the gravel base material and, where applicable, the gravel between the trenches shall consist of clean sand and gravel free of organic matter and foreign substances. The gravel shall not contain any material larger than 3 inches and up to 10% may be sized between  $\frac{3}{4}$  and 3 inches. Gravel shall meet the requirements of RI DEM OWTS Rule 6.33M. **NOTE: Gravel is not a substitute for the Specified Sand but Specified Sand can be a substitute for Gravel.**

**1.4 SEPARATION DISTANCE TO LIMITING CONDITIONS:** Measure from the *bottom of the GSF unit* to the limiting condition. The separation distance measured from the unit to ground water is a minimum 3 feet. The separation distance for impervious material as measured from the *bottom of the GSF unit* to the impervious layer is 5 feet.

**1.5 CONNECTIONS AND FITTINGS:** Connections of lines to tanks and distribution boxes must be made using watertight mechanical seals. Use of any grouting material is not permitted.

## 1.0 Design and Installation

---

**1.6 PLACING GSF MODULES:** The “White Stripe” on the GSF modules indicates the top of the module and is not intended to indicate the location of the distribution pipe. With the white stripe facing up, all rows of GSF modules are set level, end to end on the Specified Sand layer. No mechanical connection is required between modules.

**1.7 DISTRIBUTION PIPE:** SDR-35 or equivalent is required. Place perforated pipe on top of GSF modules with holes at 4 and 8 o'clock. Secure pipe to GSF modules with provided wire clamps, one clamp per Eljen module. All distribution piping must meet a minimum 2,500-pound crush test specification or meet the requirements of the most recent revision of ASTM D 2665 for polyvinyl chloride (PVC) drain and waste pipe. Furthermore, all piping must meet state and local regulations.

**1.8 DISTRIBUTION BOX:** Set the gravity system D-box outlet invert a minimum of 1/8 inch drop in elevation per linear foot to the top of the first module in the trench. Set a 2-inch minimum drop for dosed systems from the D-box to the modules. Ensure that the distribution box and pipes feeding the system are placed on settled soil. Flow Dials may be used in either Gravity or Dosed installations.

**1.9 COVER FABRIC:** Geotextile cover fabric is provided by Eljen Corporation for all GSF systems. It is placed over the top and sides of the module rows to prevent long term siltation and failure. **Cover fabric substitution is not allowed.** Fabric should drape vertically over the pipe and must not block holes in the distribution pipe or be stretched from the top of the pipe to the outside edge of the modules. “Tenting” will cause undue stress on fabric and pipe.

**1.10 BACKFILL & FINISH GRADING:** Complete backfill with a minimum of 12 inches of clean porous fill measured from the top of modules. Backfill can be native material meeting the requirements of RI DEM OWTS Rule 6.33O, ASTM C33 sand, or RIDEM specified gravel per OWTS Rule 6.33M. Backfill exceeding 18 inches requires venting at the far end of the trench. Use well graded native soil fill that is clean, porous and devoid of large rocks. Do not use wheeled equipment over the system. A light track machine may be used with caution, avoiding crushing or shifting of pipe assembly. Divert surface runoff from the Effluent Disposal Area, (EDA). Finish grade to prevent surface ponding, topsoil and seed system area to protect from erosion.

**1.11 ADDITIONAL FACTORS AFFECTING RESIDENTIAL SYSTEM SIZE:** Homes with expected higher than normal water usage may consider increasing the septic tank volume. Consideration for disposal area may be up-sized for expected higher than normal water use.

For example:

- Luxury homes, homes with a Jacuzzi style tubs, and other high use fixtures.
- Homes with known higher than normal occupancy.

**1.12 GARBAGE DISPOSALS:** The use of a garbage disposal is not recommended as they can cause septic system problems by generating an increased amount of suspended solids, grease and nutrients. However, if such units are proposed to be used the septic tank capacity shall be increased in accordance with the RI DEM OWTS Rules.

NOTE: Eljen requires the use of septic tank outlet effluent filters on all systems. Filters with higher filtration are recommended for systems with garbage disposals.

**1.13 WATER SOFTENER BACKWASH:** At no time should water softener backwash be disposed of in the septic system. Water softener backwash should be discharged to a separate soil absorption field.

**1.14 SEPTIC TANKS:** Many designers are now specifying dual compartment tanks for all their systems. Eljen supports this practice as it helps to promote long system life by reducing TSS and BOD to the effluent disposal area. Gas baffles and/or effluent filters are also required.

**1.15 SEPTIC TANK FILTERS:** Septic tank effluent filters are **REQUIRED** on the outlet end of the septic tank. Filter manufacturers require that filters be cleaned from time to time. Ask your installer or designer for specific cleaning requirements based on the type or make of the filter installed. Eljen requires the septic tank to be pumped every three years or as needed which would be a good time to check and conduct filter maintenance.

# 1.0 Design and Installation

**1.16 SYSTEM VENTING:** It is required to vent all systems that are over 18" below finished grade and systems beneath any surface condition that would not allow for surface air exchange with the system. See Section 7.0 for a more detailed explanation of venting GSF products.

**1.17 NUMBER OF GSF MODULES REQUIRED:** System size will vary depending on design flow and soil conditions. Residential systems use a minimum of six (6) B43 modules per bedroom. See Sections 2.0 and 3.0 for more information on systems sizing.

**1.18 TRENCH SPACING:** For systems with the distribution lines below original grade, the edge to edge spacing is 6 feet. For systems on sloping sites and systems with the distribution lines above original grade, the edge to edge spacing for Eljen GSF modules is 11 feet. Repair installations may request lesser spacing per section 6.18G.2 of the RI DEM OWTS Rules.

**1.19 TRENCH LENGTH:** Maximum trench lengths as defined by RI DEM OWTS Rule 6.34C are as follows:

- a) Without dosing – 50 ft
- b) With tipping distribution box – 75 feet or
- c) With a pump – 100 feet

**1.20 CROSS OVER DESIGN:** This trench design is efficient for maintaining a trench configuration while minimizing the overall impact to the absorption area.

FIGURE 3: CROSS OVER DESIGN

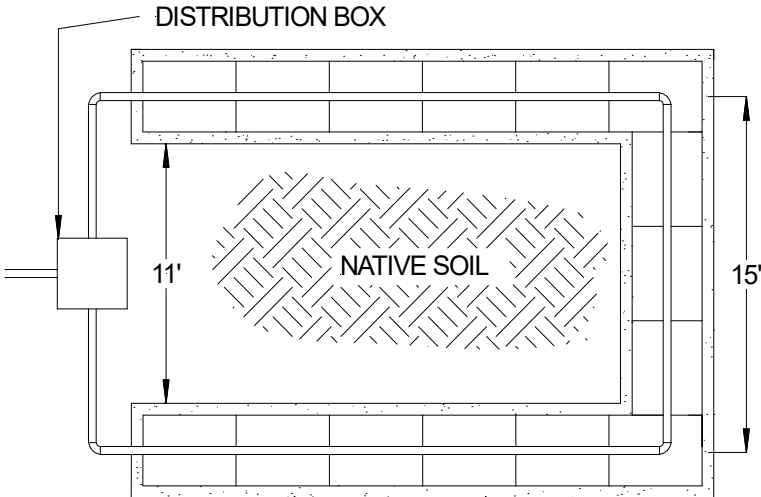

*NOTE: This design layout can also be installed in elevated or shallow placement systems. See Rule 33.5 for details.*

**1.21 SIZING GSF SYSTEMS:** System size is determined based on loading rates established during a soil evaluation or as directed by RIDEM OWTS Rules. Table 2 provides system sizing guidelines based on design flow, soil types, and corresponding loading rates. Simply divide the design flow by the appropriate loading rate to determine the minimum square feet of system area required. Each Eljen B43 GSF module is sized at 7 sf/lf or 28 sf per B43 module. Please see design examples for more information.

## 1.0 Design and Installation

**TABLE 2: ELJEN B43 GSF SYSTEM SIZING**

Number of Bedrooms	Design Flow (GPD)	Soil Category (*See Note Below)	Soil Loading Rate (g/sf/d)	Minimum Number of B43 Modules
1	115	1,3,4,6m	0.70	6
		1m, 2,4,6,7m	0.61	7
		5, 7	0.52	8
		8	0.46	9
		8m	0.48	9
		9	0.40	11
		9m	0.43	10
2	230	1,3,4,6m	0.70	12
		1m, 2,4,6,7m	0.61	14
		5, 7	0.52	16
		8	0.46	18
		8m	0.48	18
		9	0.40	21
		9m	0.43	20
3	345	1,3,4,6m	0.70	18
		1m, 2,4,6,7m	0.61	21
		5, 7	0.52	24
		8	0.46	27
		8m	0.48	26
		9	0.40	31
		9m	0.43	29
4	460	1,3,4,6m	0.70	24
		1m, 2,4,6,7m	0.61	27
		5, 7	0.52	32
		8	0.46	36
		8m	0.48	35
		9	0.40	42
		9m	0.43	39
5	575	1,3,4,6m	0.70	30
		1m, 2,4,6,7m	0.61	34
		5, 7	0.52	40
		8	0.46	45
		8m	0.48	43
		9	0.40	52
		9m	0.43	48

Note: \* m denotes soils with coarse fragment modifiers.

Note: Table 2 represents the information provided in 6.16L of the RI DEM OWTS Rules. Divide the minimum leaching area required by 28 sf per B43 module to determine the number of Eljen B43 Modules required for the design. Comprehensive system design examples are also located within this manual.



## 2.0 Trench Installation Sizing and Guidelines

### Trench Example Using Soil Category Loading Rates:

House size: 4 Bedrooms  
 Table 2 Soil Category: Type 3 (0.70 gal/sf/day)  
 Design Flow – 115 gpd x 4 bedrooms: 460 gpd

Required System Area in Square Feet:  $460 \text{ gpd} \div 0.70 \text{ gal/sf/day} = \mathbf{657.1 \text{ ft}^2}$

Eljen GSF linear feet required:  $657 \text{ ft}^2 \div 7 \text{ ft}^2/\text{lf} = \mathbf{93.9 \text{ linear feet}}$

Number of Eljen GSF B43 Modules Required:

Field Length  $\div$  4 ft per module

$93.9 \text{ lf} \div 4 \text{ ft per module} = 23.4 \text{ modules (always round up) or } \mathbf{24 \text{ B43 Modules}}$

For this example, assume the number of trenches equals two:

Trench Width: Module width (3ft) + Sand Sidewalls (6" + 6"): 4 ft  
 Trench Length: 24 modules  $\div$  2 trenches = 12 12 B43 modules per row  
 Modules (12) x 4 lf/module + 1 ft (6" sand at each end of trench): 49 ft  
 Trench area (width x length x trenches): 4 ft x 49 ft x 2 trenches: 392 ft<sup>2</sup>

#### Trench Dimensions:

Length =	49 ft/trench
Width =	4 ft
Trenches =	2
Modules =	24 B43
Total Area provided =	392 ft <sup>2</sup>
Credited Area provided =	672 ft <sup>2</sup>

FIGURE 4: PLAN VIEW –TRENCH SYSTEM

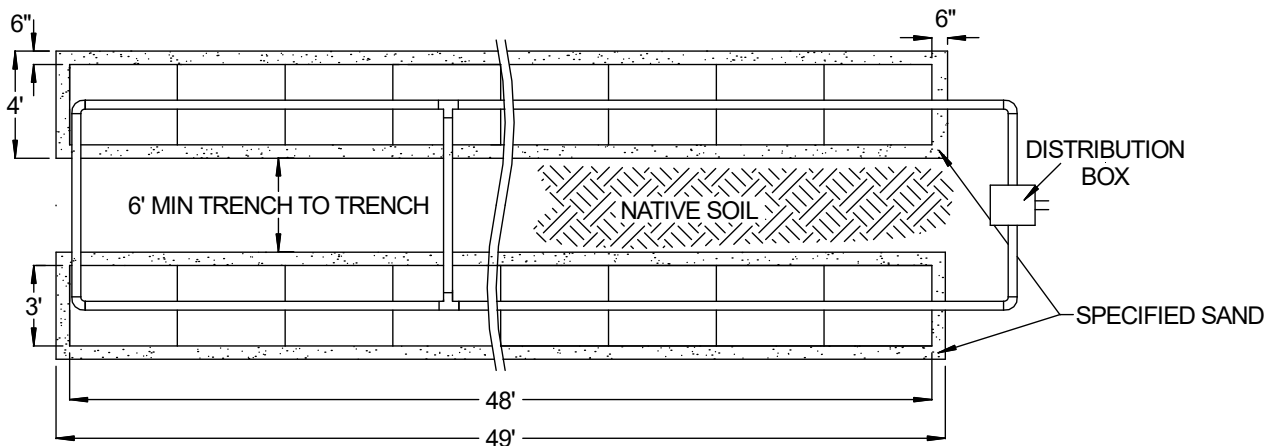

NOTE: 4-inch distribution pipe used to connect ends must be solid pipe.

NOTE: Effluent shall be applied to trenches at least every 25 feet. See RI DEM OWTS Rule 6.35K. This can be done by "butterflying" the system at the mid-point with a d-box or installing a cross-over pipe at the mid-point of the system. Contact Eljen's Technical Service Department with any questions.

NOTE: This design layout can also be installed in elevated or shallow placement systems. See RI DEM OWTS Rule 6.34F for details.

## 2.0 Trench Installation Sizing and Guidelines

### Trench Example Using Percolation Rates:

House size:	3 Bedrooms
Percolation Rate of 20 mpi from Table 2:	0.52 gal/sf/day
Design Flow – 115 gpd x 3 bedrooms:	345 gpd
Required System Area in Square Feet:	$345 \text{ gpd} \div 0.52 \text{ gal/sf/day} = \mathbf{663.5 \text{ ft}^2}$
Eljen GSF linear feet required:	$663.5 \text{ ft}^2 \div 7 \text{ ft}^2/\text{lf} = \mathbf{94.8 \text{ linear feet}}$
Number of Eljen GSF B43 Modules Required:	
Field Length $\div$ 4 ft per module:	
94.8 lf $\div$ 4 ft per module = 23.7 modules (always round up) or	<b>24 B43 Modules</b>

For this example, assume the number of trenches equals two: *Note: Max trench length for gravity systems is 50 ft.*

Trench Width: Module width (3ft) + Sand Sidewalls (6" + 6"):	4 ft
Trench Length: 24 modules $\div$ 2 trenches = 12	12 B43 modules per row
Modules (12) x 4 lf/module + 1 ft (6" sand at each end of trench):	49 ft
Trench area (width x length x trenches): 4 ft x 49 ft x 2 trenches:	392 ft <sup>2</sup>

#### Trench Dimensions:

Length =	49 ft/trench
Width =	4 ft
Trenches =	2
Modules =	24 B43
Total Area provided =	392 ft <sup>2</sup>
Credited Area provided =	672 ft <sup>2</sup>

FIGURE 5: PLAN VIEW – TRENCH SYSTEM

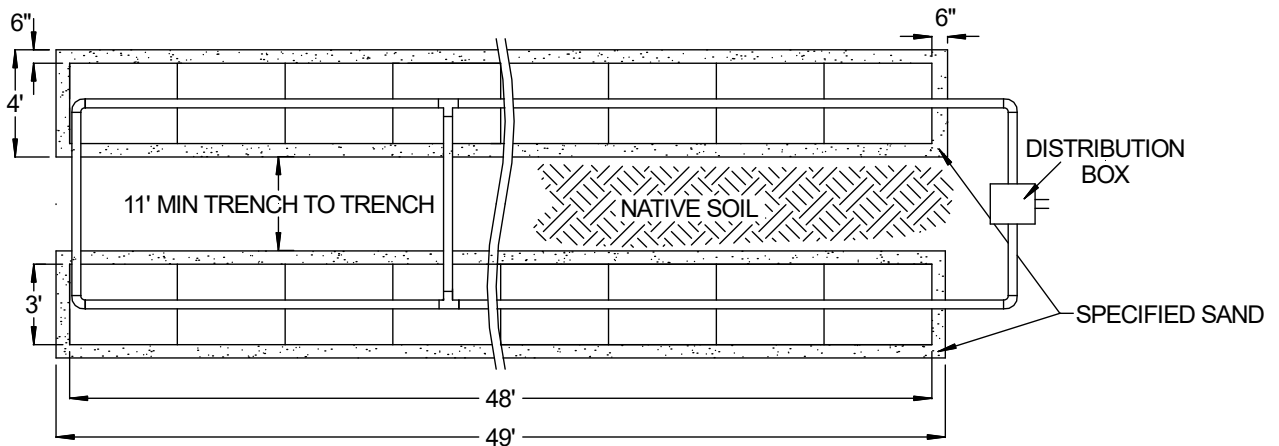

NOTE: 4-inch distribution pipe used to connect ends must be solid pipe.

NOTE: Effluent shall be applied to trenches at least every 25 feet. See RI DEM OWTS Rule 6.35K.2. This can be done by "butterflying" the system at the mid-point with a d-box or installing a cross-over pipe at the mid-point of the system. Contact Eljen's Technical Service Department with any questions.

NOTE: This design layout can also be installed in elevated or shallow placement systems. See RI DEM OWTS Rule 6.34F for details.

## 2.0 Trench Installation Sizing and Guidelines

FIGURE 6: PLAN VIEW – TRENCH SYSTEM – LEVEL SITE

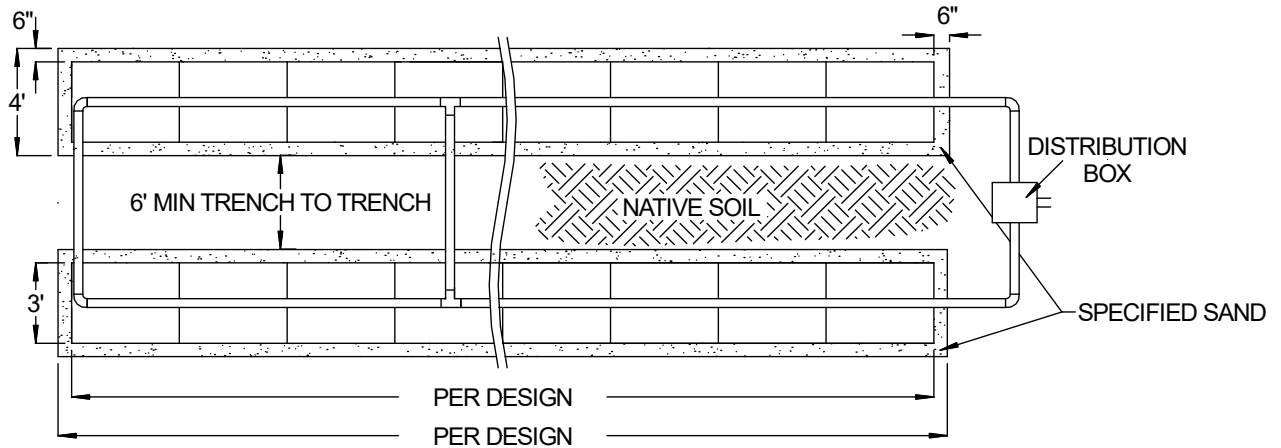
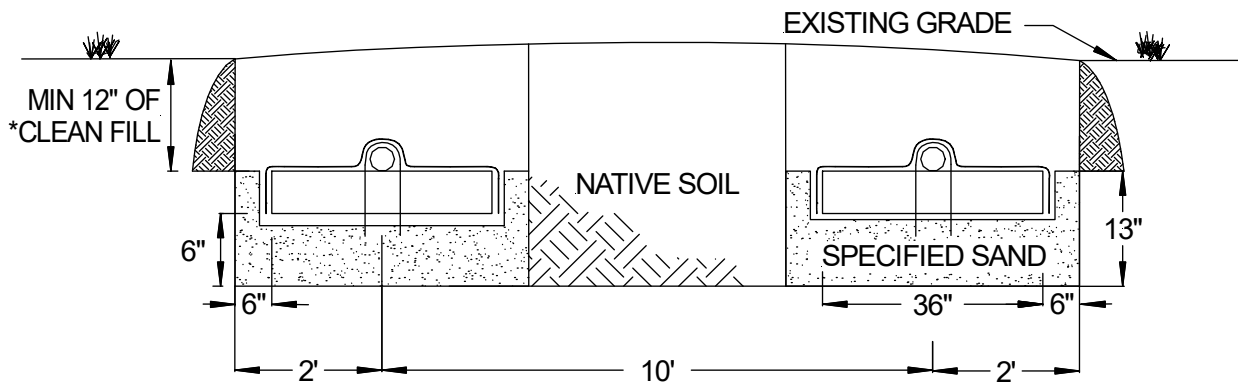

FIGURE 7: SECTION VIEW – TRENCH SYSTEM – LEVEL SITE



NOTE: 4-inch distribution pipe used to connect ends must be solid pipe.

NOTE: Effluent shall be applied to trenches at least every 25 feet. See RI DEM OWTS Rule 6.35K. This can be done by "butterflying" the system at the mid-point with a d-box or installing a cross-over pipe at the mid-point of the system. Contact Eljen's Technical Service Department with any questions.

NOTE: This design layout can also be installed in elevated or shallow placement systems. See RI DEM OWTS Rule 6.34F for details.

NOTE: \*Clean fill above the units can be native material meeting the requirements of RI DEM OWTS Rule 6.330, ASTM C33 sand, or RIDEM specified gravel per OWTS Rule 6.33M.

## 2.0 Trench Installation Sizing and Guidelines

FIGURE 8: PLAN VIEW – TRENCH SYSTEM – SLOPING SITE

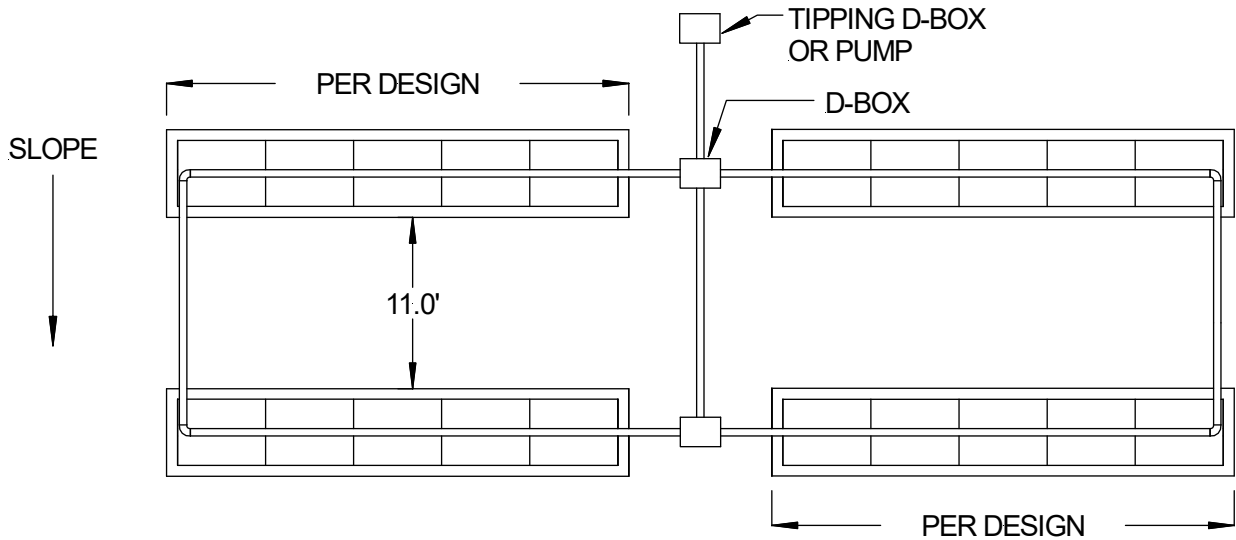

NOTE: System can also be end fed. Please call Eljen Corporation with any questions.

FIGURE 9: SECTION VIEW – TRENCH SYSTEM – SLOPING SITE

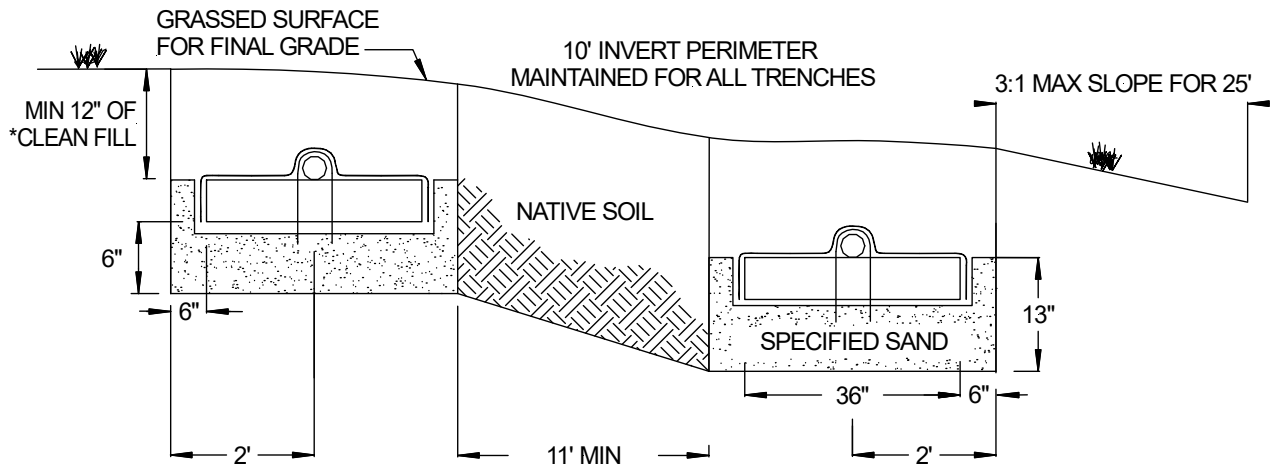

NOTE: For Sloping Sites please adhere to the following requirements of RI DEM OWTS Rule 6.34G. (1) A tipping distribution box or pump shall be used. (2) The ends of the distribution lines shall be connected by a relief line that is non-perforated, SDR 35 PVC laid with water tight joints that are of the same diameter as the perforated pipe that connects it. (3) Each dispersal trench must meet the adjacent side slope requirement of RI DEM OWTS Rule 6.33Q.

NOTE: Effluent shall be applied at least every 25 feet. On sloping site installs, Eljen recommends by "butterflying" the system (see Figure 8) and using a tipping d-box not a cross over pipe to control distribution. Per RI DEM OWTS Rule 6.34C.2, the ends of system rows shall be connected with solid pipe. Extra care must be taken to verify that the ends of the system rows are at the same elevation as the beginning of each row to prevent hydraulic overloading of lower rows.

NOTE: \*Clean fill above the units can be native material meeting the requirements of RI DEM OWTS Rule 6.33O, ASTM C33 sand, or RIDEM specified gravel per OWTS Rule 6.33M.

## 2.0 Trench Installation Sizing and Guidelines

---

1. Ensure all components leading to the GSF system are installed properly. Septic tank effluent filters are required with the GSF system.
2. Determine the number of GSF Modules required using the trench sizing example.
3. Prepare the site. Do not install a system in saturated ground or wet soils that are smeared during excavation. Keep machinery off infiltrative areas.
4. Plan all drainage requirements above (up-slope) of the system. Set soil grades to ensure that storm water drainage and ground water is diverted away from the absorption area once the system is complete.
5. Excavate the trench; scarify the receiving layer to maximize the interface between the native soil and specified sand.
6. Minimize walking in the trench prior to placement of the specified sand to avoid soil compaction.
7. Place Specified Sand in one 6-inch lift and compact. The compacted height below the GSF module must be level at 6 inches. A hand tamping tool, excavation bucket or vibrating compactor are acceptable methods.
8. Place GSF modules with **PAINTED STRIPE FACING UP**, end to end on top of the specified sand along their 4-foot length.
9. A standard 4-inch perforated pipe, SDR 35 or equivalent, is centered along the modules 4-foot length. Orifices are set at the 4 & 8 o'clock position.
10. All 4-inch pipes are secured with manufacturers supplied wire clamps, one per module.
11. (Pressure Distribution Systems) Insert a pressure pipe (size per design and code) into the standard 4-inch perforated pipe. The pressure pipe orifices are set at the 12 o'clock position as shown in Figure 11. Each pressure lateral will have a drain hole at the 6 o'clock position. Each pressure lateral shall have a clean out at the end of the trench.
12. **Cover fabric substitution is not allowed.** The installer should lay the Eljen provided geotextile cover fabric lengthwise down the trench, with the fabric fitted to the perforated pipe on top of the GSF modules. Fabric should be neither too loose, nor too tight. The correct tension of the cover fabric is set by:
  - a. Spreading the cover fabric over the top of the module and down both sides of the module with the cover fabric tented over the top of the perforated distribution pipe.
  - b. Place shovelfuls of Specified Sand directly over the pipe area allowing the cover fabric to form a mostly vertical orientation along the sides of the pipe. Repeat this step moving down the pipe.
13. Place 6 inches of Specified Sand along both sides of the modules edge. A minimum of 6 inches of Specified Sand is placed at the beginning and end of each trench.
14. Complete backfill with a minimum of 12 inches of clean porous fill measured from the top of the module. Backfill exceeding 18 inches requires venting at the far end of the trench. Use well graded native soil fill that is clean, porous and devoid of large rocks. Do not use wheeled equipment over the system. A light track machine may be used with caution, avoiding crushing or shifting of the pipe assembly.
15. Divert surface runoff from the system. Finish grade to prevent surface ponding. Topsoil and seed system area to protect from erosion.

### 3.0 Elevated Trench Guidelines

---

1. Ensure all components leading to the GSF system are installed properly. Septic tank effluent filters are required with the GSF system.
2. Determine the trench dimensions using the design example.
3. Prepare the site. Do not install a system on saturated ground or wet soils that are smeared during excavation. Keep machinery off infiltrative areas.
4. Plan all drainage requirements above (up-slope) of the system. Set soil grades to ensure that storm water drainage and ground water is diverted away from the absorption area once the system is complete.
5. Remove A Horizon and scarify the receiving layer to maximize the interface between the native soil and the Specified Sand & Gravel. Minimize walking in the absorption area prior to placement of the Specified Sand to avoid soil compaction.
6. Properly compacted gravel that meets the requirements of RI DEM OWTS Rule 6.33M shall be placed throughout the excavation to an elevation that will be 2 inches above the top of the distribution lines. Dispersal trenches shall be excavated out of the compacted gravel. There shall be a minimum 6 inch gravel base layer meeting the requirements of RI DEM OWTS Rule 6.33M below the Specified Sand.
7. Place Specified Sand in one 6-inch lift and compact. The compacted height below the GSF module must be level at 6 inches. A hand tamping tool, excavation bucket or vibrating compactor are acceptable methods.
8. Place GSF modules with **PAINTED STRIPE FACING UP**, end to end on top of the specified sand along their 4-foot length.
9. A standard 4-inch perforated pipe, SDR 35 or equivalent, is centered along the modules 4-foot length. Orifices are set at the 4 & 8 o'clock position.
10. All 4-inch pipes are secured with manufacturers supplied wire clamps, one per module.
11. (Pressure Distribution Systems) Insert a pressure pipe (size per design and code) into the standard 4-inch perforated pipe. The pressure pipe orifices are set at the 12 o'clock position as shown in Figure 11. Each pressure lateral will have a drain hole at the 6 o'clock position. Each pressure lateral shall have a clean out at the end of each module row.
12. **Cover fabric substitution is not allowed.** The installer should lay the Eljen provided geotextile cover fabric lengthwise down the row, with the fabric fitted to the perforated pipe on top of the GSF modules. Fabric should be neither too loose, nor too tight. The correct tension of the cover fabric is set by:
  - a. Spreading the cover fabric over the top of the module and down both sides of the module with the cover fabric tented over the top of the perforated distribution pipe.
  - b. Place shovelfuls of Specified Sand directly over the pipe area allowing the cover fabric to form a mostly vertical orientation along the sides of the pipe. Repeat this step moving down the pipe.
13. Place a minimum of 6 inches of Specified Sand along both sides of the modules edge. A minimum of 6 inches of Specified Sand is placed at the beginning and end of each module row. A minimum of 12 inches of Specified Sand is placed in between module rows.
14. Complete backfill with a minimum of 12 inches of clean porous fill measured from the top of the unit. Backfill exceeding 18 inches over the unit requires venting at the far end of the bed. Use well graded native soil fill that is clean, porous and devoid of large rocks. Do not use wheeled equipment over the system. A light track machine may be used with caution, avoiding crushing or shifting of pipe assembly.
15. Divert surface runoff from the system. Finish grade to prevent surface ponding. Topsoil and seed system area to protect from erosion.

## 3.0 Elevated Trench Guidelines

---

FIGURE 10: SECTION VIEW – ELEVATED TRENCH SYSTEM

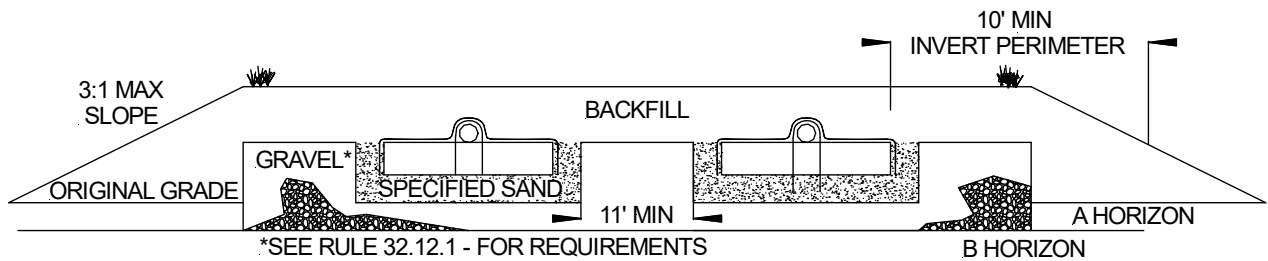

*Note: Elevated trench systems can be pressurized (LPP) or pump dosed.*

## 4.0 Dosing Distribution Guidance

---

**4.1 PUMP DISTRIBUTION BOX:** Specify an oversized distribution box for pumped systems. Provide velocity reduction in the D-box with a tee or baffle. Set D-box invert 2 inches higher than invert of perforated pipe over GSF modules. If the absorption area is installed deeper than 18 inches, the system must be vented. See Section 7.0 of this manual for detailed information on venting of systems.

**2.2 DOSING DESIGN CRITERIA:** Dosing volume must be set to deliver a maximum of **4 gallons per B43 Module** per dosing cycle. Head loss and drain back volume must be considered in choosing the pump size and force main diameter. A valve on the force main is recommended to set the flow rate so that the orifices on the outlet pipes are submerged and the d-box does not overflow.

## 5.0 Pressure Distribution Guidance

Standard procedures for design of pressure distribution networks apply to the GSF filter. A minimum orifice size of 1/8 to 1/4 inch shall be maintained. A 1/4 inch diameter drain hole is required at the 6 o'clock position of each pressure lateral for drainage purposes. The lateral pipe network (*size per design and code*) is placed within a standard 4-inch perforated pipe. The perforations in the 4-inch outer pipe are set at the 4 and 8 o'clock position, the drilled orifices on the pressure pipe are set to spray at the 12 o'clock position directly to the top of the 4-inch perforated pipe as shown below.

FIGURE 11: PRESSURE PIPE PLACEMENT

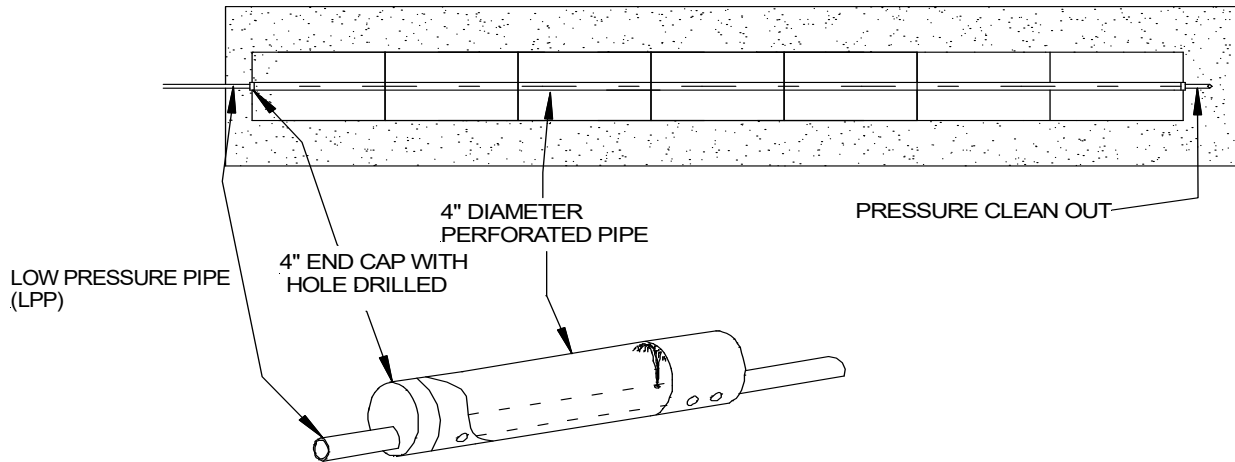

PRESSURE PIPE CROSS SECTION FOR ALL APPLICATIONS

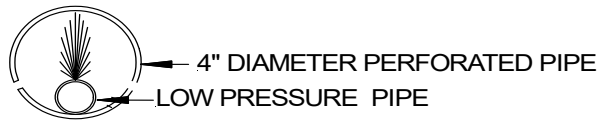
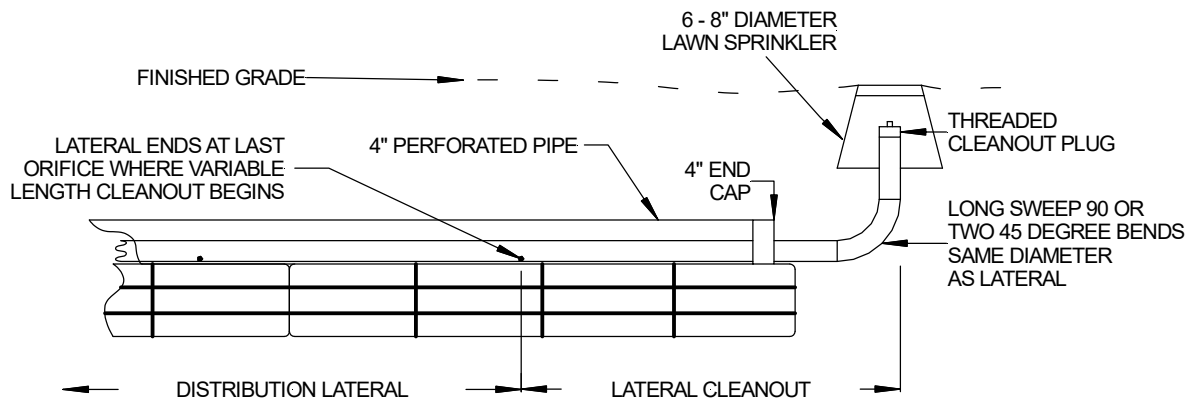

FIGURE 12: PRESSURE CLEAN OUT





## 5.0 Pressure Distribution Guidance

---

FIGURE 13: CONTOURED TRENCH PRESSURE DISTRIBUTION

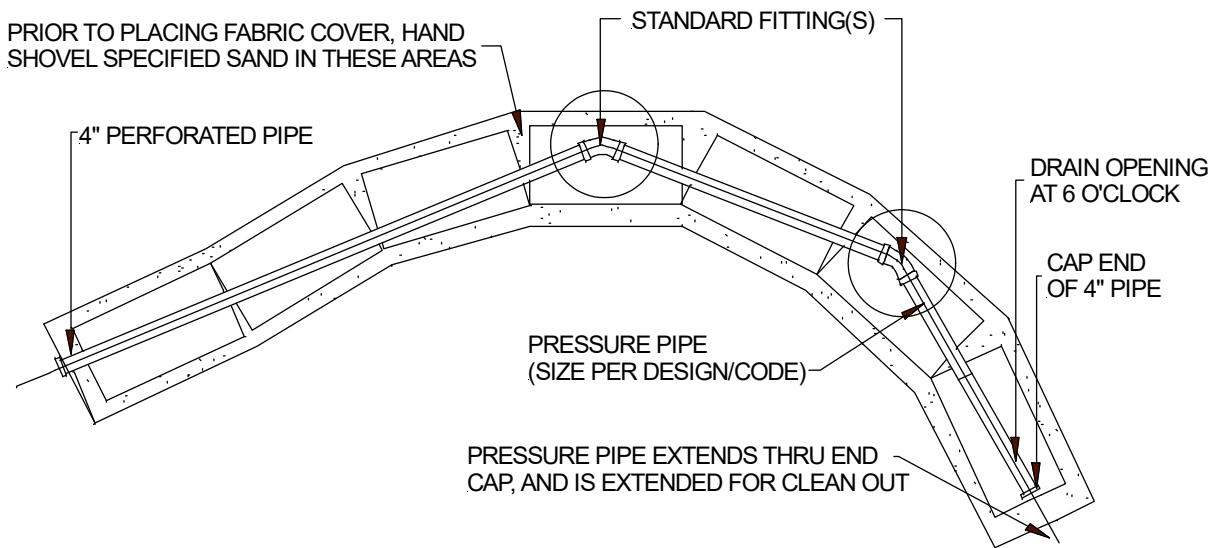

GSF Pressure Distribution trench placed on a contour or winding trenches to maintain horizontal separation distances.

## 6.0 Pump Controls

---

Demand and Pressure Dosed controlled systems will include an electrical control system that has the alarm circuit independent of the pump circuit, controls and components that are listed by UL or equivalent, are located outside, within line of sight of the pump chamber and are secure from tampering and resistant to weather (minimum of NEMA 4). The control panel shall be equipped with cycle counters and elapsed time meters. Where a water supply water meter is available it may be possible to eliminate the counters or timers.

The control panel shall be equipped with both audible and visual high liquid level alarms installed in a conspicuous location. Float switches shall be mounted independent of the pump and force main so that they can be easily replaced and/or adjusted without removing the pump.

## 7.0 System Ventilation

---

**7.1 SYSTEM VENTILATION:** Air vents are required on all absorption systems **with more than 18 inches of cover material** as measured from the top of the GSF module to the finished grade. This will ensure proper aeration of the modules and sand filter. Under normal operating conditions, only a fraction of the filter is in use. The unused channels remain open for intermittent peak flows and the transfer of air.

**7.2 VENT PIPE FOR LOW PRESSURE DISTRIBUTION SYSTEMS:** If the system is a low-pressure distribution system with greater than 18 inches of cover, ensure that the LPP clean outs are located in the vent for easy access.

## 7.0 System Ventilation

FIGURE 14: GRAVITY VENTING

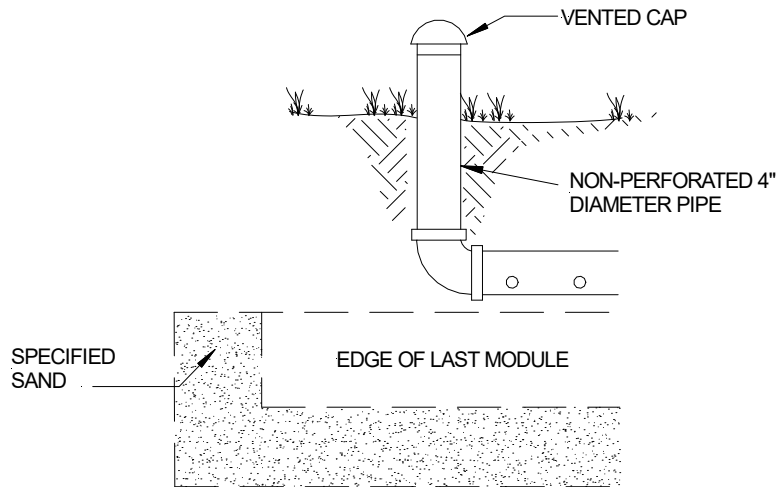

**7.3 VENTILATION FOR PRESSURE AND DEMAND DOSED SYSTEMS:** If a pressure or demand dosed system is specified with greater than 18 inches of cover, an additional 2-inch minimum airline must be extended from the GSF D-box back to a knockout or riser on the septic tank or pump chamber. This maintains the continuity of airflow from the field into the house plumbing.

FIGURE 15: AIR BY-PASS LINE CROSS SECTION FOR VENTING OF PUMPED DOSED SYSTEM

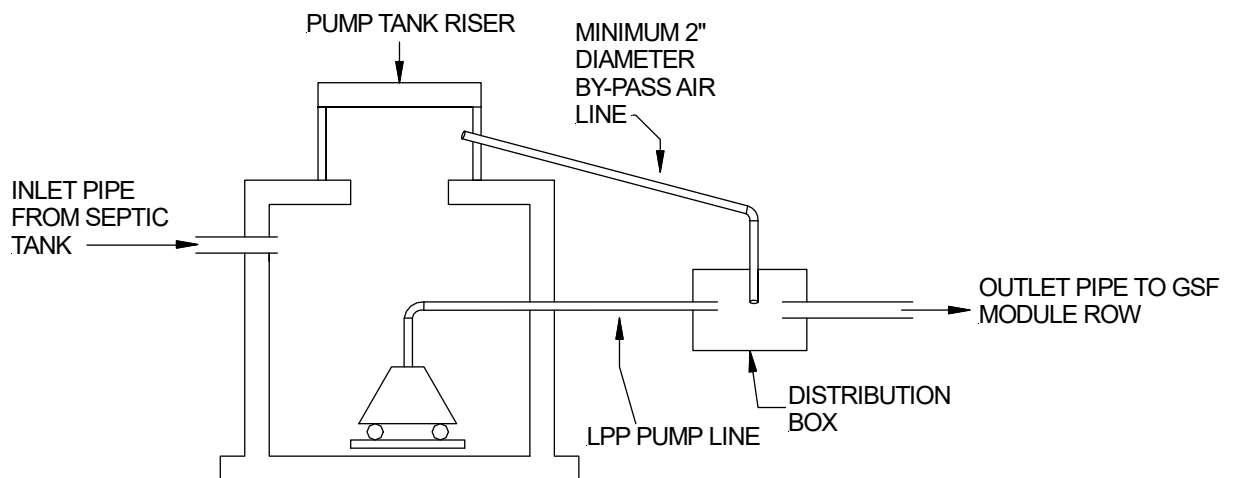

## 7.0 System Ventilation

FIGURE 16: PRESSURE CLEAN OUT PRESSURE DOSED SYSTEMS

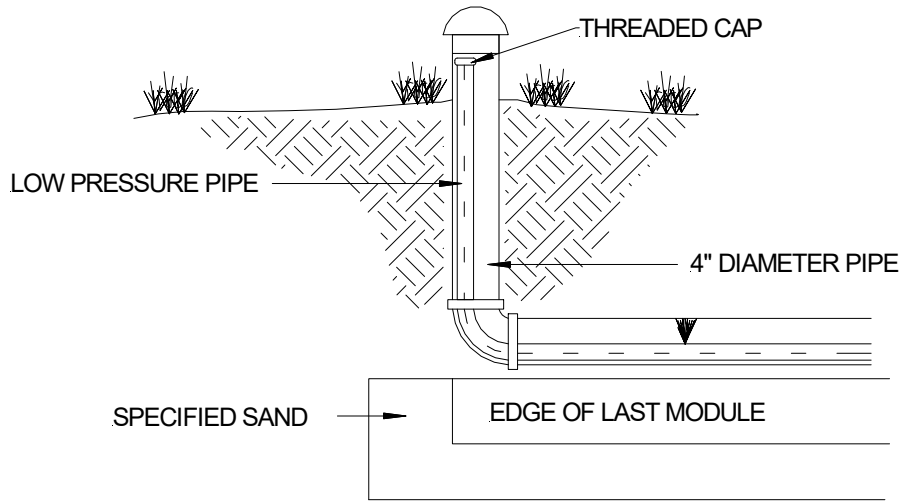

**7.4 VENTILATION PLACEMENT:** In a GSF system, the vent is usually a 4-inch diameter pipe extended to a convenient location behind shrubs, as shown below. Corrugated pipe may be used. If using corrugated pipe, ensure that the pipe does not have any bends that will allow condensation to pond in the pipe. This may close off the vent line. The pipe must have an invert higher than the system so that it does not drain effluent.

FIGURE 17: GSF WITH 4" VENT EXTENDED TO CONVENIENT LOCATION

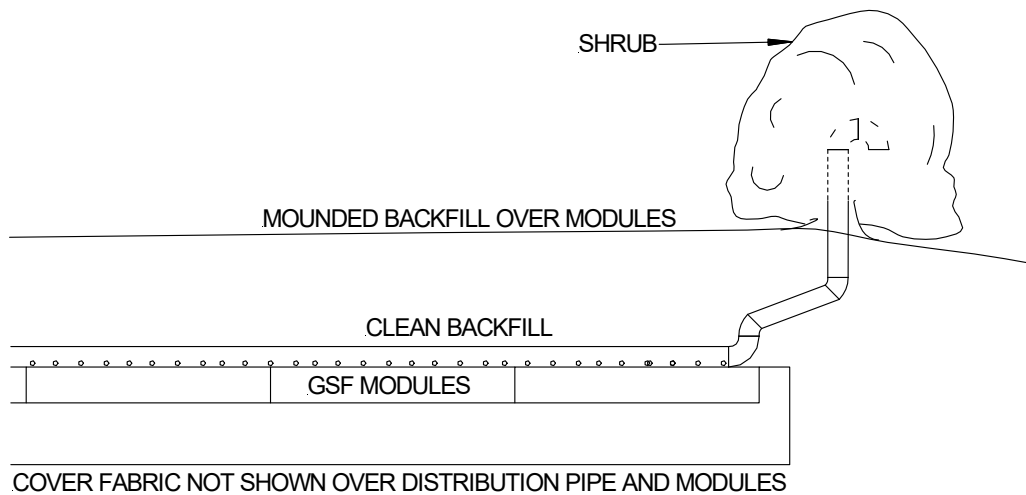

## 8.0 GSF Inspection Check List

Geotextile Sand Filter, (GSF) Checklist				
Facility Owner:				
Facility Address:				
Installation Date: (MDY)				
Previous Inspection Date: (MDY)				
Date of Inspection: (MDY)				
Residential Number of Bedrooms:				
Is this a Commercial Design? If yes, what type:	Yes	No		
What is the estimated BOD5 and TSS strength?	BOD5	TSS	Comments	
Observation Port Location(s):	1	2	3	
Inspection Data, (complete all fields)				
Is daily flow within the system design flow? If no, explain:	Yes	No		
Does the owner verify the system use as described above? If no, explain:	Yes	No		
Septic tank last inspection date:	Date			
Inspected by:				
Septic tank last pumped date:				
Is pumping recommended?	Yes	No		
Condition of the soil absorption system: Wet, Dry, Firm, Soft, Vegetative, or Other. If Other, explain:	W	D	S	F V
Is there evidence of storm water flows or erosion over the septic system? If yes, explain:	Yes	No		

## 8.0 GSF Inspection Check List

Is there evidence of soil slump or compaction by traffic or other means in the vicinity of the soil absorption system? If yes, describe:	Yes	No	Comments
Is effluent visible through the observation port? If yes, describe the condition and the fluid level:	Yes	No	Comments
Is there a garbage disposal in the home?	Yes	No	Comments
Is a water softener connected to the system?	Yes	No	Comments
Are solids visible through the observation port? If yes, describe the condition and depth of solids:	Yes	No	Comments
Is there evidence of surcharging or effluent ponding in the D-Box? If yes, describe and measure:	Yes	No	Comments
Are the system vents in place?	Yes	No	Comments
Are they operational? If no, describe conditions and location:	Yes	No	
Describe any other pertinent issues:			

Inspected by:	
License Number:	
Date:	
Time:	
Print Name & Signature of Inspector:	
<p><b><i>I certify I have inspected the system at the above address, completed this report, and the information reported is true, accurate, and complete.</i></b></p>	

## **COMPANY HISTORY**

Established in 1970, Eljen Corporation created the world's first prefabricated drainage system for foundation drainage and erosion control applications. In the mid-1980s, we introduced our Geotextile Sand Filter products for the passive advanced treatment of onsite wastewater in both residential and commercial applications. Today, Eljen is a global leader in providing innovative products and solutions for protecting our environment and public health.

## **COMPANY PHILOSOPHY**

Eljen Corporation is committed to advancing the onsite industry through continuous development of innovative new products, delivering high quality products and services to our customers at the best price, and building lasting partnerships with our employees, suppliers, and customers.



90 Meadow Road, Windsor, CT 06095 • Tel: 800-444-1359 • Fax: 860-610-0427

**[www.eljen.com](http://www.eljen.com)**

